

No. B18443 01404A

# INSTRUCTION MANUAL

## DIESEL GENERATOR

MODEL :

D C A - 1 3 E S K - D A  
D C A - 1 5 E S K - D A  
D C A - 2 5 E S K - D A

 **Denyo Asia Pte Ltd**

HEAD OFFICE

27 Pioneer Sector 1, Jurong, Singapore 628433

Tel : 65-686 10058

Fax : 65-679 69067

## FOREWORD

- \* Your machine is a portable type diesel generating set.
- \* Do not install, operate or repair this machine without reading this operating manual.
- \* This generator set (machine) must be operated by a person having sufficient knowledge and skill for the sake of safety.

### Notes on instruction manual

- \* This instruction manual explains correct operation and maintenance of the machine to ensure its performance.  
Incorrect handling of the machine may lead to a serious injury or decease.  
Before using, be sure to read this manual carefully.  
Particularly, the items under " Safety precautions",  
"⚠ WARNING" and "⚠ CAUTION" must be read thoroughly.
- \* Keep this manual in the case behind the rear or side door for future reference.
- \* Read the contents of the warranty card attached to the machine.
- \* If this manual becomes illegible by spot or damage, contact distributor or our office to get new manual.

- Contents -

1. Safety Precautions	-----	1
2. Construction	-----	8
2-1 Outline and parts names	-----	8
2-2 Operating panel, control panel and parts names	-----	10
2-3 Meters	-----	11
2-4 Use switches and controllers	-----	14
3. Transportation and installation	-----	16
3-1 Transportation of machine	-----	16
3-2 Installation of machine	-----	16
4. Connecting the load	-----	18
4-1 Cables to be used	-----	18
4-2 Connecting the load	-----	19
4-3 Grounding	-----	21
5. Operation	-----	22
5-1 Checking prior to operation	-----	22
5-2 Startup	-----	26
5-3 Handling during operation	-----	28
5-4 Shutdown	-----	29
5-5 Protection device	-----	30
6. Lubrication, cooling water and fuel	-----	31
6-1 Engine oil	-----	31
6-2 Cooling water	-----	32
6-3 Fuel	-----	32
7. Handling of battery	-----	33
7-1 Caution on battery charge	-----	34
7-2 Connection of booster cable, and installation	-----	35
8. Periodical checking and maintenance	-----	36
8-1 Maintenance schedule	-----	38
8-2 Checking/first 50 hours	-----	39
8-3 Checking/every 100 hours	-----	40
8-4 Checking/every 200 hours	-----	41
8-5 Checking/every 400 hours	-----	41
8-6 Checking/every 500 hours	-----	42
8-7 Checking/every 1000 hours	-----	42
8-8 Checking/every 2000 hours	-----	42
8-9 Other checks and Maintenance	-----	42
8-10 Table of periodical maintenance and checking	-----	43
9. Troubleshooting	-----	44

10. Long-term storage	----- 46
11. Service data	----- 47
11-1 Specifications	----- 47
11-2 AC generator specifications (for custom voltage)	----- 48
11-3 Outline drawing	----- 49
11-4 Generator connection diagram	----- 52
11-5 Engine wiring diagram	----- 57
12. Options instruction Manual	----- 58
12-1 Earth leakage relay	----- 58

## 1. Safety Precautions

In order to ensure safe operation, the following symbols are used for explanation of the machine operation.

The following symbols, found throughout this manual, alert you to potentially dangerous conditions to the operator, service personnel, or the equipment.

### WARNING:

This symbol refers to a hazard or unsafe practice which can result in severe personal injury or death.

### CAUTION:

This symbol refers to a hazard or unsafe practice which can result in personal injury or product or property damage.

### [Note] :

This symbols show handling precautions for effective operation and many years of satisfactory operation.

Some of the items shown by " CAUTION" may also cause death or serious injury. Be sure to observe all the items, as they are important for safe operation.

- \* If the machine is used by an outsider, you are requested to explain him correct handling and advise him to read this instruction manual carefully.
- \* Do not modify the machine at your discretion, as it affects the safety, performance or the life of the machine.
- \* If the machine is modified or it is used incorrectly against this manual or unauthorized parts are used, the warranty of manufacturer will become invalid.

### Safety label

Safety labels are attached to the following positions of the machine.

\* Keep these safety labels clean at all times.

\* When safety labels are spoiled or lost, contact distributor or our office specifying the nameplate No. shown below and ask for new ones.

No.	Parts name	Parts number	No.	Parts name	Parts number
1	Warning:exhaust gas	B9042 0000	5	Caution:high temp	B9052 0020
2	Warning:output voltage	B9211 0250	6	Support hook	B9121 0020A
3	Warning:fire accident	B9055 0070A	7	Warning:radiator cap	B9051 0030
4	Warning:moving part	B9050 0050			

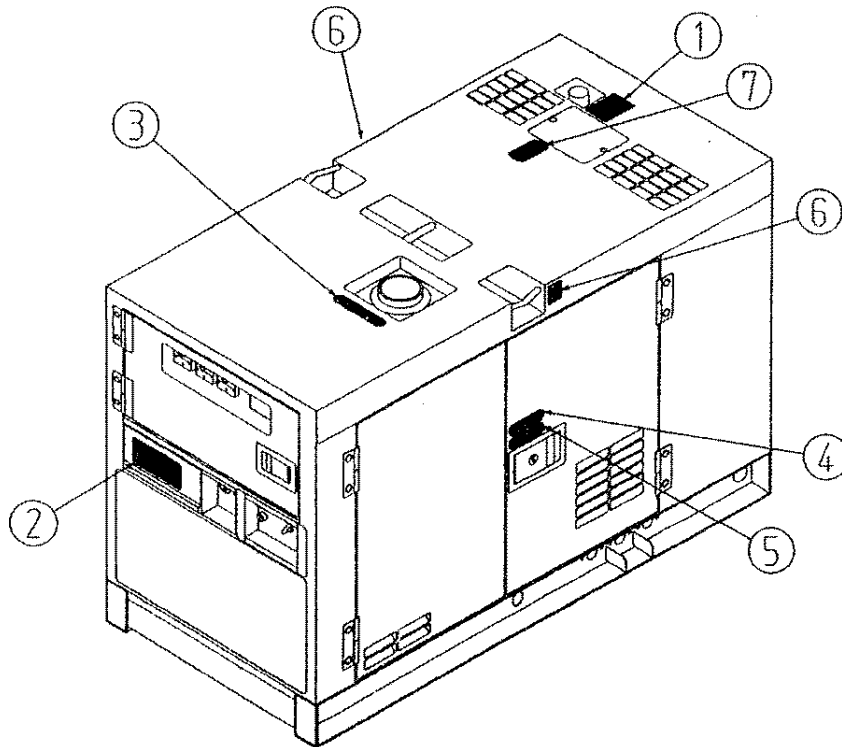

**⚠ WARNING**

**ENGINE EXHAUST can kill.**

■ Insufficient ventilation may lead to death due to lack of oxygen or poisoning by exhaust gases.

- \* Do not use the machine in a place of poor ventilation or in a place where exhaust gases stay.
- \* Do not use the machine indoors or in storehouse, tunnel, ship hold, tank, etc. of poor ventilation.
- \* If it becomes necessary to use the machine in the above places, the exhaust pipe should be extended to a well ventilated place. In this case, use a ventilator to ensure proper ventilation.
- \* Do not direct the exhaust outlet to nearby pedestrians and houses.

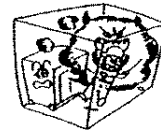
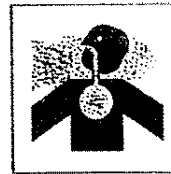

**⚠ WARNING**

**ELECTRIC SHOCK can kill.**

■ Do not touch the output terminals during operation to prevent decease due to electric shock.

- \* Never touch the output terminals during operation. If your hands or the machine are wet, it will result in a death or serious injury.
- \* When a wiring work is required, be sure to turn OFF the circuit breaker and stop the machine.
- \* Keep the output terminal cover closed and the terminal bolts tightened while the machine is running.
- \* A low voltage is generated even when the machine is in low speed idle operation. Be sure to stop the machine completely.

■ Do not touch the electrical parts in the machine during operation, as it may lead to death due to electric shock.

- \* Always close the control panel and tighten the fixing bolts before operating the machine.
- \* Always close the side door and lock it before operating the machine.
- \* When opening the control panel for voltage selection, etc., turn OFF the circuit breaker and stop the machine.

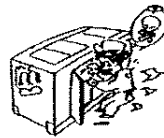

**⚠ WARNING**

**ELECTRIC SHOCK by leak can kill.**

■ Improper grounding may lead to death due to electric shock.

- \* Be sure to execute the grounding of the machine and the load according to the local rule.



**⚠ WARNING**

**MOVING PARTS can cause severe injury.**

■ Rotary unit which runs at a high speed is located in the machine. (Note that it is very dangerous if you touch it.)

- \* Be sure to close the door and lock it during operation.
- \* When the door needs to be opened during operation, do not get your hands and head in the machine to prevent them from being caught in the machine which may lead to injury.
- \* When making check or maintenance of the machine, be sure to stop the machine in advance.

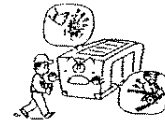
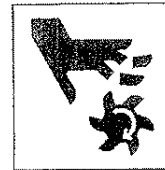

**⚠ WARNING**

**DIESEL FUEL can cause fire or explosion.**

■ Fuel and oil are flammable. Incorrect handling results in danger of ignition or fire.

- \* When fuel needs to be supplied to the machine, be sure to stop the engine. Refrain from smoking. Keep the machine away from fire.
- \* Do not leave flammable objects (paper, wood chips, etc.) and hazardous objects (oil, powder, etc.) near the machine.
- \* Wipe off spilt fuel and oil.

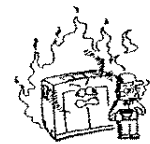

**⚠ WARNING**

**HOT COOLANT can cause severe scalds.**

■ If the radiator cap is opened while the water temperature is high, steam or hot water will spout out.

- \* During operation or immediately after stopping the machine, do not open the radiator cap while the water temperature is high.
- \* When cooling water needs to be checked or supplied, wait until the engine is cooled.





**⚠ CAUTION**

**Stacking**

■ Improper stacking of machines may cause falling or dropping accidents. When stacking other machines on this machine, be sure to observe the following points.

- \* Check that the bonnet of the machine is free from damage and that the fixing bolts are not loosened and missing.
- \* Put the machine horizontally on a solid foundation which withstands the weight of stacked machines.
- \* Machines can be stacked up to 2 stages. The weight and size of stacked machines should be less than those of this machine.
- \* Using square timbers as shown right, put each machine making sure that the weight is even.

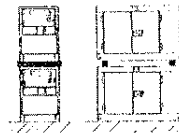

■ Do not operate the machines in the state of stacking to prevent falling or dropping accidents.

**⚠ CAUTION**

**HOT PARTS can burn skin.**

■ High temperature units are located in the machine.  
(Note that these units are very dangerous if they are used incorrectly.)

- \* Be sure to close the door and lock it during operation.
- \* If the door needs to be opened during operation, do not get your hands and head in the machine to prevent unexpected burns.
- \* When making check or maintenance of the machine, be sure to stop the machine.
- \* The bonnet is still hot even after the machine is stopped. Be careful until the engine is completely cooled.

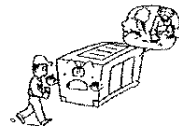

**⚠ CAUTION**

**Battery**

■ Battery generates flammable gases. Improper handling may lead to explosion or serious injury.

\* Battery should be charged in a well ventilated location. Otherwise, flammable gases are accumulated which may be ignited and exploded.

\* When connecting a booster cable, do not jumper the terminals (+ and -). Otherwise, the flammable gases generated from the battery may be ignited and exploded by sparks.

\* For maintenance of the machine, disconnect the ground cable on the ground side.

■ The battery acid is dilute sulfuric acid. Improper handling will cause unexpected burns.

\* When the battery acid gets on your clothes or skin, wash it out with a large volume of water immediately. If it gets in your eyes, wash with a large volume of water immediately and consult your doctor. In the worst case, it will put out your eyes.

■ For checking or handling of the battery, be sure to stop the engine and turn OFF the battery switch in advance.



**⚠ CAUTION**

**Operator**

■ Do not operate the machine if operator is tired too much or drinks some alcohol or take some drugs.

\* Otherwise, it may cause unexpected accidents or injury.

■ During checking or maintenance, be sure to put on suitable clothes and protectors.

\* Do not put on baggy clothes, necklace, etc., because they are easily caught by projections which may cause injuries.

**⚠ CAUTION**

**Noise**

■ This machine generates large noise if the door is open. Surrounding to large noise may cause hearing trouble.

- \* Close and lock the door during operation.
- \* If opening the door is necessary during operation, be sure to put on the ear protector.



**⚠ CAUTION**

**Connection to house wiring**

■ Before connecting this machine to any building's electrical system, a licensed electrician must install an isolation(transfer) switch.

- \* Serious injury or death may result without this transfer switch.

**⚠ CAUTION**

**Transportation**

■ Do not lift the machine at the support hook or the ladder because it is not strong enough for lifting and may cause a falling accident.

- \* When lifting the machine, use the hanger located at the roof center.
- \* Keep out under the lifted machine.

■ Do not lift or do not transport the machine during operation, as it may cause damage to the fan or serious trouble.

- \* When loading the machine on the truck or the like, fix the machine firmly by support hooks on the both side.

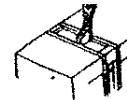

## 2. Construction

### 2-1 Outline and parts names

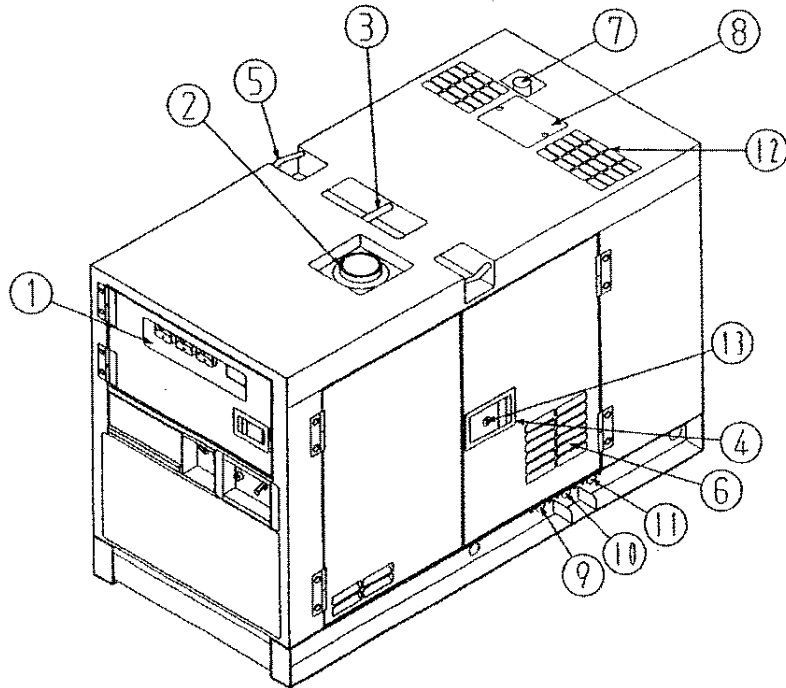

- |                            |                        |
|----------------------------|------------------------|
| 1. CONTROL PANEL           | 8. COOLANT IN          |
| 2. FUEL IN                 | 9. FUEL DRAIN PLUG     |
| 3. HANGER ROD              | 10. OIL DRAIN PLUG     |
| 4. DOOR LATCH              | 11. COOLANT DRAIN PLUG |
| 5. SUPPORT HOOK (FOR ROPE) | 12. VENTILATION        |
| 6. AIR INTAKE              | 13. KEY                |
| 7. EXHAUST GAS OUTLET      |                        |

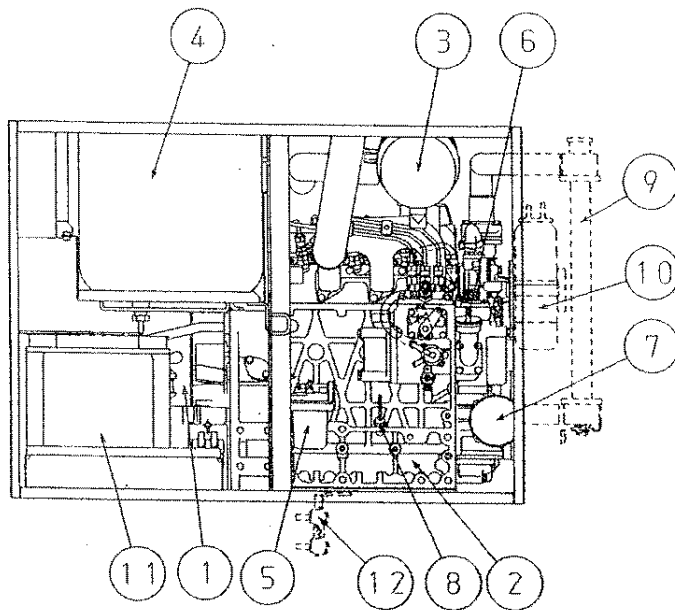

- |                  |                          |
|------------------|--------------------------|
| 1. AC GENERATOR  | 7. OIL FILTER            |
| 2. DIESEL ENGINE | 8. OIL LEVEL GAUGE       |
| 3. AIR CLEANER   | 9. RADIATOR              |
| 4. FUEL TANK     | 10. COOLANT RESERVE TANK |
| 5. FUEL FILTER   | 11. BATTERY              |
| 6. OIL INLET     | 12. THREE - WAY VALVE    |
|                  | (OPTION)                 |

2-2 Operating panel, control panel and parts names

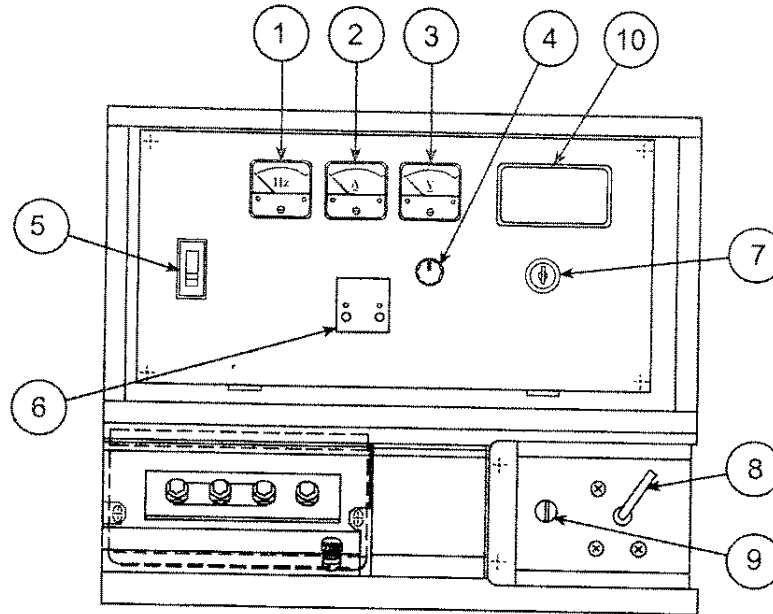

- 1. FREQUENCY METER
- 2. AC AMMETER
- 3. AC VOLTMETER
- 4. VOLTAGE REGULATOR
- 5. AC CIRCUIT BREAKER
- 6. EARTH LEAKAGE RELAY (OPTION)
- 7. STARTER SWITCH
- 8. THROTTLE LEVER
- 9. FREQUENCY ADJUST SCREW
- 10. ENGINE MONITOR
  - NUMBER INDICATION : RUN HOURS
  - LAMP INDICATION : FUEL LEVEL, PREHEAT
  - WARNING LAMPS : WATER TEMP., OIL PRESS., CHARGING

## 2-3 Meters

### Engine monitor

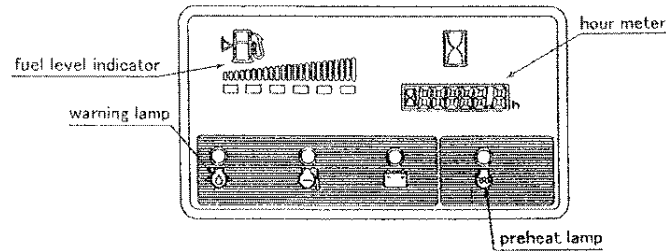

#### (1) Fuel level indicator

That indicates a fuel level in the fuel tank. Green lamps will turn on with full tank. As the fuel level drops, the numbers of the turn-on lamps decrease and at the sometime the color of lamps changes from green to red.

Replenish the tank when there becomes only one lamp turned on. The table below shows the relation between numbers of turn-on lamps and fuel level.

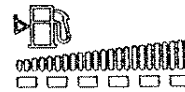

Numbers of lamps turned-on	Color of lamps	Fuel level (L)
6	all green	55 to full
5	all green	45 to 54
4	all green	35 to 44
3	all green	27 to 34
2	all red	19 to 26
1	all red	0 to 18

#### (2) Hour meter

This meter indicates the total running time of the engine.

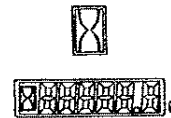

## Generator indicators

### (1) Frequency meter

This meter indicates frequency of the output voltage. Make sure that it indicates 50Hz during operation.

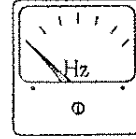

### (2) AC ammeter

This meter indicates AC current flowing into the connected load. Make sure that it is always pointing below the rated current.

When running the three phase and single phase loads together, this meter indicates total current of them.

When running either the three phases or single-phase load, this meter indicates the current flowing into the load.

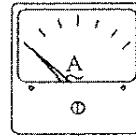

### (3) AC voltmeter

This meter indicates AC output voltage. Make sure that it indicates rated voltage.

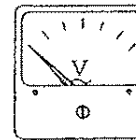



## Indication/alarm lamp

### (1) Preheat lamp

When the starter switch is set in the "PREHEAT" position, this lamp goes on.  
In a little time this lamp goes off, indicating that the machine has been preheated to be ready for startup.



### (2) Warning Lamps

This monitor indicates the following failures, if any one of them occurs.

#### ① High jacket water temperature

This lamp goes on when the water temperature rises abnormally.

If this lamp goes on during operation, the emergency stop device immediately operates to shut down the engine automatically.



#### ② Oil pressure failure

If this machine is in normal operation, this lamp stays off. When the starter switch is turned to "RUN" position to start the engine, the lamp goes on, and when the oil pressure rises after startup, it goes off.

If this lamp goes on during operation, the emergency stop device immediately operates to shutdown the engine automatically.



#### ③ Insufficient charge

This lamp goes on when the output voltage of the alternator drops unusual value.

If this lamp goes on during operation, the emergency stop device immediately operates to shutdown the engine automatically.

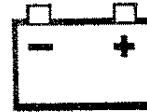

## 2-4 Use of switches and controllers

### Switches

#### (1) Starter switch

##### Functions:

##### ① Stop

This switch should be set in this position unless the machine is in operation. The key can be inserted or pulled out in this position.



##### ② Run

This switch should be set in this position when the machine is in operation.



##### ③ Start

This is the position to start the engine. When your hand is released from the key after starting, it is automatically set in the position of "RUN".



##### ④ Preheat

This is the position to start the engine when the air temperature is low. Set the switch in this position until the preheat lamp goes off, and then set it in the start position.



#### (2) Speed control device

##### · Throttle lever

This lever is used to control the engine speed. Set the lever at the "START/IDLING" position for startup or warm up/cooling operation of the engine and at the "RUN" position for constant speed operation of the machine (at 50Hz or 60Hz).

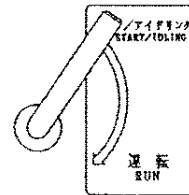

##### · Frequency adjusting screw

This screw is used to adjust the frequency. With the throttle lever set at the "RUN" position, turn the screw to the "HIGH" side to increase the frequency and to the "LOW" side to decrease it.

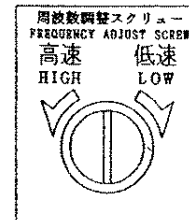

### (3) Circuit breaker

This is a main switch to supply power to a load. When the load is shorted or in the state of overload, it trips to protect the generator against trouble.

[Note] :

Do not use this circuit breaker to turn ON/OFF the load, to prevent damage to the circuit breaker.

When it trips with over-current, the handle of the breaker stops between ON and OFF positions. This is what is called the trip condition.

In this case, push the handle down to the OFF position to reset it, or else, it cannot be set in ON position.

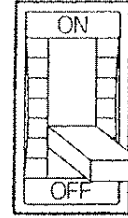

### Voltage regulator

#### (1) Voltage regulator

This regulator is used to control the output voltage. Turn the regulator to clockwise to increase the voltage and counter-clockwise to decrease it. Adjust the voltage to the rated voltage with this regulator.

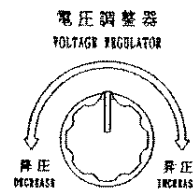

### 3. Transportation and installation

#### 3-1 Transportation of machine

**⚠ CAUTION**

**Transportation**

■ Do not lift the machine at the support hook or the ladder because it is not strong enough for lifting and may cause a falling accident.

- \* When lifting the machine, use the hanger located at the roof center.
- \* Keep out under the lifted machine.

■ Do not lift or do not transport the machine during operation, as it may cause damage to the fan or serious trouble.

- \* When loading the machine on the truck or the like, fix the machine firmly by support hooks on the both side. The detail as machine size is referred to

[11-1. Specifications See p.47, 48]

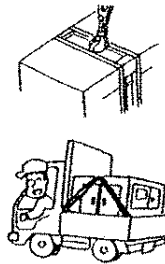

#### 3-2 Installation of machine

**⚠ WARNING**

**ENGINE EXHAUST can kill.**

■ Insufficient ventilation may lead to death due to lack of oxygen or poisoning by exhaust gases.

- \* Do not use the machine in a place of poor ventilation or in a place where exhaust gases stays.
- \* Do not use the machine indoors or in storehouse, tunnel, ship hold, tank, etc. of poor ventilation.
- \* If it becomes necessary to use the machine in the above places, the exhaust pipe should be extended to a well ventilated place. In this case, use a ventilator to ensure proper ventilation.
- \* Do not direct the exhaust outlet to nearby pedestrians and houses.

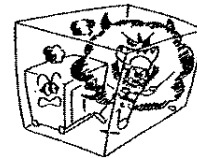
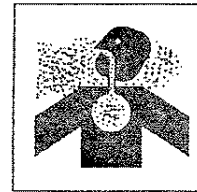

**[Note] vibration:**

The engine, running, generates vibration during operation of the machine.

When installing the machine, be sure to observe the following points.

- \* Install the machine horizontally on a solid foundation. Operation on an uneven place will generate unusual vibration.
- \* The machine should be installed on a substantial base to prevent claims from nearby living people. For details of the vibration level of the machine and foundation work, contact distributor or our office.

**[Note] noise:**

The engine is running during operation of the machine.

If the door is open, much noise will be generated. But some noise will stay, when door is closed.

When installing the machine, be sure to observe the following points.

- \* Close and lock the door after installation.
- \* We recommend to execute the measure for sound level to prevent claims from nearby living people.

**Installation procedure**

- \* Install the machine horizontally on a solid foundation.
- \* Provide a space of more than about 1m at the side of the control panel and fuel feed port to ensure correct operation and supply.
- \* Provide a space of more than about 1.2m on the left and right sides for check of the engine, oil supply and cable connection work.
- \* A sufficient space is required at the top of the machine to allow hot air (exhaust air) from the radiator and exhaust gases to be discharged and to supply water to the radiator.
- \* When the machine is operated in a place with much dust or salt, careful maintenance is required to prevent clogging or damage to the radiator or poor insulation of electric parts.

**Indoor installation**

- \* Exhaust gases should be discharged outdoors using an exhaust pipe.
- \* Exhaust air should also be discharged outdoors using a duct or the like.
- \* Insufficient indoor ventilation will raise the (indoor) temperature and affects the performance of the machine.
- \* For details of required volume of ventilation, contact distributor or our office.

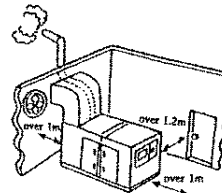

## 4. Connecting the load

### 4-1 Cables to be used

#### Selection of cables

Use cables having sufficient size in consideration of the allowable current of the cables and the distance between the machine and the load.

If the load current exceeds the allowable current of cables, the cable may be damaged by overheat. Also, if the cables are too small in size for the length, the input voltage of the load drops which lowers the working efficiency or causes failure in operation.

Select the length and size of cable so that the voltage drop "e" obtained by the following equation is within 5% of the rated voltage.

\* Equation to obtain 3-phase, 3-wire system voltage drop "e" from the length and size of cable and operating current is as follows

$$e = \frac{1}{58} \times \frac{L}{S} \times I \times \sqrt{3}$$

where e: voltage drop (V)                      L: length (m)  
S: cable thickness (mm<sup>2</sup>)                      I: load current (A)

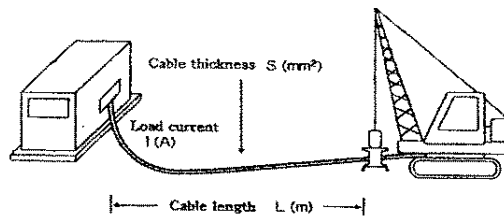

## 4-2 Connecting the load

### **⚠ WARNING**

**ELECTRIC SHOCK can kill.**

■ Do not touch the output terminals during operation to prevent decrease due to electric shock.

\* When a wiring work is required, be sure to turn OFF the circuit breaker and stop the machine.

\* When operating the engine, close the output terminal cover. Tighten the fixing bolts before operating the machine.

■ Do not use damaged cables to prevent electric shock. Insufficient tightening of bolts will generate heat at connections which may result in fire accidents.

\* When connecting, make sure the connecting cables are normal and connected firmly to the output terminals.

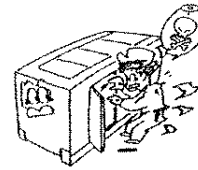

### **⚠ CAUTION**

**Connection to house wiring**

■ Before connecting this machine to any building's electrical system, a licensed electrician must install an isolation (transfer) switch.

\* Serious injury or death may result without this transfer switch.

**(1) Fastening the output terminal**

**[Note] :**

In connecting the load, tighten locking bolts securely with a spanner or the like to prevent burning.

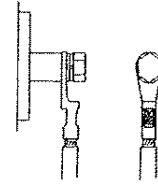

**(2) Connecting three phase output terminal**

Connect the load to the output terminal after confirmation of load phase and voltage.

Use U/V/W for three phase load  
100/110V(50Hz/60Hz)

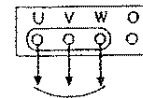
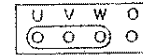

Use O/U, O/V, O/W for single phase load  
115/127V(50Hz/60Hz)

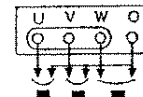

Use U/V, V/W, W/U for single phase load  
200/220V(50Hz/60Hz)

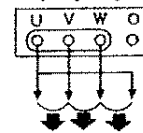

**(3) Precaution in load connection**

- ① Be sure to provide a switch for turning the load ON and OFF between the output terminal block and the load. Note that the use of the breaker of the machine for turning the load ON and OFF may result in breaker failure.
- ② In connecting the load, be sure to stop the engine and turn OFF the breakers on the control panel and the output terminal block.
- ③ Don't contact the connecting cable to the output terminal of other phase.
- ④ When the load connection is finished, close the cover of output terminal and tighten by the bolts.

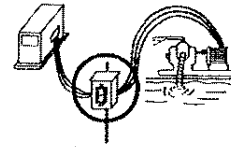



## 4-3 Grounding

### ⚠ WARNING

**ELECTRIC SHOCK** by leak can kill.

■ Improper grounding may lead to death due to electric shock.

\* Be sure to execute the grounding of the machine and the load according to the local rule.



### Grounding

Execute the grounding certainly to prevent the electric shock by leak.

#### (1) Case grounding of the machine

Use the grounding wire which sectional area conforms to the local rule.

Provide the grounding rod to satisfy the grounding resistance which conforms to the local rule.

#### (2) Case grounding of the load

Execute the grounding for the load similarly. Provide the grounding rod to satisfy the grounding resistance which conforms to the local rule.

#### (3) Precaution in grounding

- ① Select a shady and highly moist place, and bury the grounding rod in such way that its top end is completely hidden in the ground.
- ② If burying the grounding rod on the place that many pedestrians walk on, clamp the lead wire to prevent catching on it.
- ③ If the lead wire is not long enough for the connection, connect it as directed below:
  - (1) Connect the lead wire and the extension wire by soldering or sleeve coupling securely and apply insulating tape to the connection.
  - (2) Do not bury the connection in the ground.
- ④ Avoid burying of grounding rod within 2m of grounding location for lightning conductor.
- ⑤ Do not use a telephone set grounding conductor.

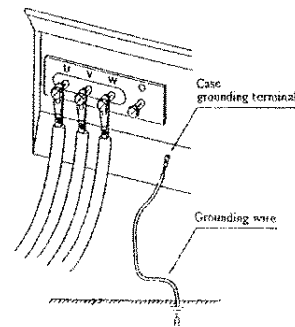

## 5. Operation

— From pre-start check to shut down —

Be sure to check the machine prior to starting.

1. Pre-start check : Check oil, cooling water, fuel and so on.
2. Periodical check: Check each part of the machine according to operating time.
3. Startup: Check the surroundings of the machine for safe operation.  
Use a sign before startup.
4. Operation: **⚠** In the machine there are moving parts, high temperature parts and high voltage parts. Before operating, close the door and lock the side door for safe operation and for prevention of noise.  
[Note] : If the warning lamp lights, stop the engine and check the cause of it.  
[Note] : Check for leaks of oil, water, exhaust gases, and for unusual noise.
5. Shut down

### 5-1 Checking prior to operation

<p><b>⚠ WARNING</b> <b>MOVING PARTS can cause severe injury.</b> ■ Rotary unit which runs at a high speed is located in the machine.(Note that it is very dangerous if you touch it.)</p> <p>* Be sure to close the door and lock it during operation. *When making check or maintenance of the machine, be sure to stop the machine in advance.</p>	
--	--

— To prevent unexpected trouble, be sure to check the following points.

- (1) Check on engine oil (lubricating oil)
- (2) Check on engine cooling water
- (3) Check on fan belt
- (4) Check on fuel
- (5) Check on battery acid
- (6) Check on grounding for electric shock protection
- (7) Check for leakage of oil and water
- (8) Check for loose parts
- (9) Removal of foreign objects in machine

## Inspection

### (1) Check on engine oil

(Read the instruction manual for the engine furnished separately.)

- ① Check the level of engine oil by the dipstick. Make sure the oil level is always between H and L.
- ② When it is below the low limit, supply oil immediately.
- ③ At the same time, check condition of oil by the dipstick.

#### [Note] :

Oil is consumed gradually during operation. When the machine is to be used continuously for a long time, be careful with lack of oil.

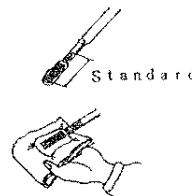

### (2) Check on engine cooling water

(Read the instruction manual for the engine furnished separately.)

#### ⚠ WARNING

**HOT COOLANT can cause severe scalds.**

■ If the radiator cap is opened while the water temperature is high, steam or hot water will spout out.

\* During operation or immediately after stopping the machine, do not open the radiator cap while the water temperature is high.

\* When cooling water needs to be checked or supplied, wait until the engine is cooled (50°C or less as measured with the water temperature gauge).

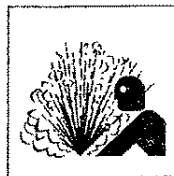

- ① Check (to see) that cooling water in the reserve tank is within the range of FULL-LOW.
- ② When it is below the low limit, supply (additional) water immediately.
- ③ Normally, only the water level of the reserve tank needs to be checked. But, the radiator cap should be opened once a week to check that water is full in the radiator.

#### [Note] :

When closing the radiator cap after water level is checked or water is supplied, turn the cap fully clockwise so that it can be firmly tightened.

Otherwise, cooling water is evaporated which results in serious damage to the engine.

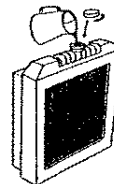
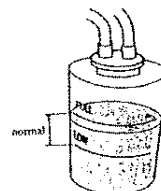

### (3) Check on fan belt

(Read the instruction manual for the engine furnished separately.)

- ① Check the belt for tension and elongation. Also, check it for damage. Replace if necessary.
- ② For adjustment or replacement of the belt, refer to the instruction manual for the engine.

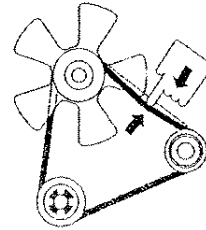

Press (about 6kg) the position shown by arrow mark (middle of belt) with your thumb.

The bend should be within the range of 10 mm.

#### Parts number of fan belt:

Model name	Parts number	Parts number of manufacture
DCA-13,15ESK	06020 11444	17123-97011
DCA-25ESK	06020 11445	17265-97021

### (4) Check on fuel

- ① Be sure to check the quantity of fuel prior to operation to prevent lack of fuel during operation.
- ② Loosen the drain plug of the fuel tank from time to time, and remove sediment's and water at the bottom of the tank.



### (5) Check on battery acid

#### ⚠ CAUTION

#### Battery

■ The battery acid is dilute sulfuric acid. Improper handling will cause unexpected burns.

\* When the battery acid gets on your clothes or skin, wash it out with a large volume of water immediately. If it gets in your eyes, wash with a large volume of water immediately and consult your doctor.

- In the worst case, it will put out your eyes.

Remove the battery acid plug(cap) and check the liquid level (10-12mm above the electrodes). Supply distilled water if necessary.

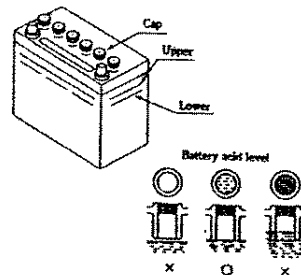

**(6) Check grounding for electric shock protection**

Make sure that the case grounding of the machine and the load are certain.

Do not ground directly 「O」 terminal.

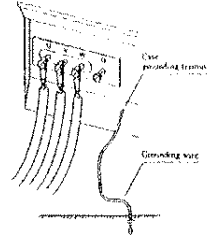

**(7) Check for leak of water and oil**

Check the machine for the trace of leak of oil or water. If a leak is found, check the location of leak and stop it.

When the leak cannot be stopped, contact our service factory.

**(8) Check for loose parts**

Check for loose bolts and nuts. Loose parts should be tightened firmly. Particularly, make check on (the fitting of air cleaner, muffler, turbo-charger, etc.), disconnection of electric wiring, short-circuit and loose terminals.

**(9) Removal of foreign objects in machine**

- \* Check that tools and cleaning cloth are not left in the machine. Remove if necessary.
- \* Check the surroundings of the muffler and engine for presence of dust and flammable objects. Remove if necessary.
- \* Check that the cooling air inlet and the cooling air outlet of the machine are not clogged with dust or other objects. Remove if necessary.

## 5-2 Startup

Following is flow of startup.

fuel filter cock : OPEN

circuit breaker : OFF

throttle lever : START / IDLING

When engine is already warm.

starter switch : PREHEAT (keep more than 5 sec.)

preheat lamp : (check the preheat lamp goes off)

starter switch : START

starter switch : RUN

engine startup

warm up operation : about 5 minutes  
sufficiently (when it is cold.)

throttle lever : RUN position

adjustment of speed

adjustment of voltage

circuit breaker : ON

supply power to load

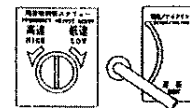
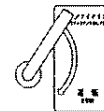
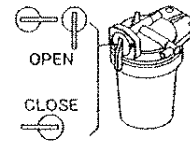

**CAUTION**

\* Do not start the engine when the machine and the load circuit breaker are "OFF" position, or else, power is supplied to the load at the start of the engine, which causes electric shocks or trouble in the load.

**Startup procedure**

Turn the fuel filler cock to open before starting engine.

- (1) Make sure that the circuit breakers of the machine and the loads are all "OFF" position.
- (2) Set the throttle handle in the "START/IDLING" position.
- (3) Turn the starter switch to "PREHEAT" position, then preheat lamp goes on. This position is held until the preheat lamp goes off, then preheat is completion. Turn the starter switch to "START" position until engine starts.

**[Note] :**

If the engine is warm, the preheat operation is not required.

- (4) If engine starts up, set free the starter switch. Make sure that 「Oil Pressure Failure」 and 「Insufficient charge」 in the warning lamp unit goes off.
- (5) Drive the machine for warming up the engine for about 5 minutes at the "START/IDLING" position of the throttle lever.
- (6) After warming up the engine, set the throttle lever to the "RUN" position. And check on the idling speed is as specified in the following table by the frequency meter. If the idling speed is not as specified or change of frequency is required, adjust the idling speed by the frequency adjust screw.

	Frequency (No Load Position)
Operation at 50Hz	52.5Hz (1575min <sup>-1</sup> )
Operation at 60Hz	62.5Hz (1875min <sup>-1</sup> )

If the idling speed set above speed, frequency becomes nearly 50Hz or 60Hz in the rated load.

- (7) Set the voltage to the rated by the voltage regulator, and turn the breaker to "ON". The machine starts power transmission state.

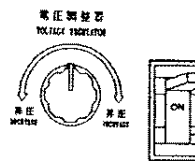
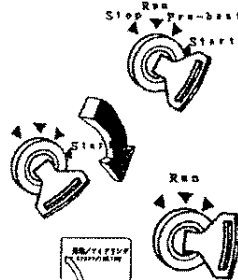
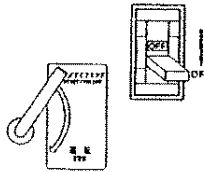
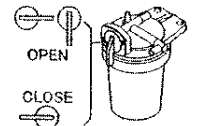

### 5-3 Handling during operation

#### (1) Checking after startup

① Make sure that each meter and lamp are normal.

normal : warning lamp is all off

② Make sure that the color of exhaust gases from the engine is normal. Check for unusual noise and vibration.

Color of exhaust gases

Colorless or light blue: Normal

Black: Abnormal, incomplete combustion

White: Abnormal, combustion of oil due to failure of oil

#### (2) Adjustment during operation

Set the frequency meter to the rated by the frequency adjust screw.

Set the voltmeter to the rated by the voltage regulator.

#### [Note] :

Do not set the throttle lever in "START/IDLING" position or do not decrease the speed by the frequency adjust screw during operation of the load, or else, the generator voltage and frequency will go down, resulting in failure in operation of the load device or any other trouble.



## 5-4 Shutdown

(1) Turn "OFF" the circuit breaker of the load.

circuit breaker of the load

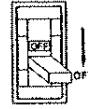

(2) Turn "OFF" the circuit breaker of the machine.

circuit breaker of the machine

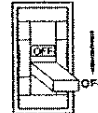

(3) Set the throttle lever in "START/IDLING" position and put the machine in cooling operation for about 5 minutes.

(4) Set the starter switch in "STOP" position. The engine will stop immediately.

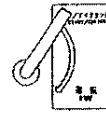

(5) Remove the key from the starter switch and keep it at hand.

starter switch

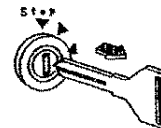

(6) After engine is shut down, turn the fuel filter cock sideways to "CLOSE".

(7) Check the amount of fuel. Supply additional fuel if necessary.

(8) Check for leakage of oil, fuel and water.

### 5-5 Protection device

Protection devices and emergency stop devices are provided for protection of the machine against trouble during operation.

When the warning lamp lights, stop the engine immediately. Check and remove the cause of trouble.

**Table of protection device**

action warning	turn OFF the circuit breaker	stop the engine	indicate by warning lamp	function
Oil pressure failure low lubricating oil (OIL PRESS.)	—	○	○	When the oil pressure falls abnormally, the device acts. Set point: 0.049MPa
High jacket water temperature (WATER TEMP.)	—	○	○	When the cooling water temperature rises abnormally, the device acts. Set point: 115°C
Insufficient charge	—	○	○	When insufficient charge, the device acts.
Fuel level failure (FUEL LEVEL)	—	—	○	When fuel supply is necessary because of fuel shortage, the device acts.
Over-current of generator	○	—	—	When over-current flows, the device acts.

## 6. Lubrication, cooling water and fuel

### 6-1 Engine oil

Use specified engine oil, otherwise, it greatly affects the startup operation and life of the engine.

(1) Kind of oil

Use oil, CD class or higher, classified by API service.

(2) Oil viscosity

Recommended oil viscosity is SAE 10W-30, all-season type.

Use oil according to ambient temperature referring to the table below.

Ambient temperature (°C)						
-30	-20	-10	0	10	20	30
		← SAE 20 →				
			← SAE 30 →			
← SAE 5W-20 →						
← SAE 10W-30 →						
← SAE 15W-40 →						

[Note] :

Do not mix with different kind of oil, or else, it deteriorates the oil quality.

(3) Total quantity of replacement oil

DCA-13, 15ESK 5.6 L

DCA-25ESK 7.6 L

## 6-2 Cooling water

### (1) Water for cooling

Use the mixture of the good quality soft water like city water and the Long Life Coolant (LLC) of anti-freeze and anti-rust for the aluminum radiator. Percentage of LLC must be 30% to 50%. Under 30%, the anti-rust effect will decrease, and over the 50%, the anti-freeze effect will decrease.

The following percentages are recommended for each ambient temperature;

30%:  $-15^{\circ}\text{C}$

40%:  $-20^{\circ}\text{C}$

50%:  $-30^{\circ}\text{C}$

In case of replenishment, use LLC of the same brand and the same density.

Normally LLC should be replaced every 2 years.

### (2) Total quantity of cooling water

DCA-13,15ESK 6.4 L (0.9 L)

DCA-25ESK 7.9 L (0.9 L)

(Value in parenthesis is reserve tank capacity.)

## 6-3 Fuel

### (1) Fuel to be used

#2 Diesel Fuel

#### [Note] :

If other kinds of fuel is used or fuel being used contains water or dust, it deteriorates the engine performance or leads to a serious trouble.

## 7. Handling of battery

### ⚠ CAUTION

#### Battery

- Battery generates flammable gases.  
Improper handling may lead to explosion or serious injury.
- \* Battery should be charged in a well ventilated location. Otherwise, flammable gases are accumulated which may be ignited and exploded.
- \* When connecting a booster cable, do not jumper the terminals (+ and -). Otherwise, the flammable gases generated from the battery may be ignited and exploded by sparks.
- \* For maintenance of the machine, disconnect the cable on the ground side.
- The battery acid is dilute sulfuric acid. Improper handling will cause unexpected burns.
- \* When the battery acid gets on your clothes or skin, wash it out with a large volume of water immediately. If it gets in your eyes, wash with a large volume of water immediately and consult your doctor.  
- In the worst case, it will put out your eyes.
- For checking or handling of the battery, be sure to stop the engine in advance.



## 7-1 Caution on battery charge

### Charging of loaded battery

- \* Disconnect the wiring cable from the battery terminals before charging.  
(Otherwise, the alternator may be damaged due to unusual voltage applied to the alternator)
- \* When disconnecting the wiring cables from the battery terminals, remove the ground cable first.  
(If a tool touches the space between the "+" terminal and the machine, electric spark will occur which is very dangerous)  
When connecting the wiring cables to the battery terminals, connect the ground cable last.
- \* While the battery is being charged, open all the liquid plugs to discharge the gas.  
Keep the battery away from fire to prevent unexpected explosion.  
Handle the battery carefully to prevent electric sparks.
- \* If the battery is overheated (liquid temperature above 45°C), stop charging for a while.
- \* At the completion of charging, stop charging immediately.  
(The relation between battery charge condition and specific gravity See p.41)  
If the battery is still charged, the following trouble will occur.
  - 1) Battery overheat
  - 2) Decrease in battery acid
  - 3) Deterioration of battery performance
- \* Do not connect the battery polarity in reverse (connection of "+" and "-" or "-" and "+") to prevent damage to the alternator or the like.

## 7-2 Connection of booster cable, and installation

When the engine is started using booster cables, connect the cables as follows.

### (1) Connection of booster cable

- ① Connect the clip of the booster cable "A" to the terminal "+" of the machine in trouble.
- ② Connect the other clip of the booster cable "A" to the terminal "+" of the normal machine.
- ③ Connect the clip of the booster cable "B" to the terminal "-" of the normal machine.
- ④ Connect the other clip of the booster cable "B" to the engine block of the machine in trouble.

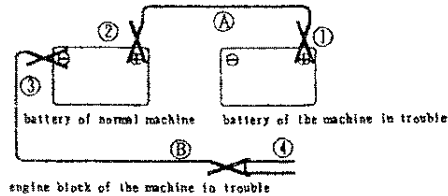

### (2) Removal of booster cable

- ① Remove the clip of the booster cable "B" connected to the engine block of the machine in trouble.
- ② Remove the clip of the booster cable "B" connected to the terminal "-" of the normal machine.
- ③ Remove the clip of the booster cable "A" connected to the terminal "+" of the normal machine.
- ④ Remove the clip of the booster cable "A" connected to the terminal "+" of the machine in trouble.

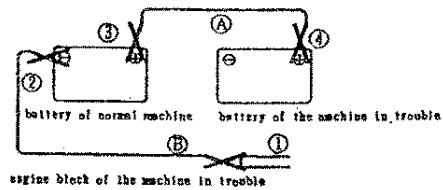

### (3) Caution on handling of booster cable

- ① Use booster cables and clips of the size that matches the size of battery.
- ② The battery used for normal machine should be the same in capacity as the battery of the machine in trouble.
- ③ After connection, check that clips are firmly connected.
- ④ When connecting booster cables, make sure that the terminal "+" does not touch the terminal "-".
- ⑤ The engine block should be connected at a place more than 30cm away from the battery.

## 8. Periodical checking and maintenance

(Read the instruction manual for the engine furnished separately)

### ⚠ WARNING

**MOVING PARTS can cause severe injury.**

■ Rotary unit which moving parts at a high speed is located in the machine. Care should be taken during operation.

\* When the machine needs checking or maintenance, be sure to stop it in advance.

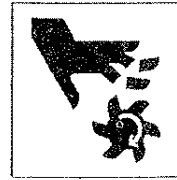

### ⚠ WARNING

**ELECTRIC SHOCK can kill.**

■ High voltage units are located in the machine. Care should be taken during operation.

\* When the machine needs checking or maintenance, be sure to stop it in advance.

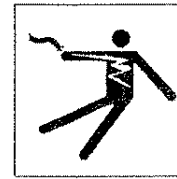

### ⚠ CAUTION

**HOT PARTS can burn skin.**

■ High temperature parts are located in the machine. Care should be taken during operation.

\* When the machine needs checking or maintenance, be sure to stop it in advance.

\* Even after the machine stops, the inside of the bonnet is still hot. Wait until the engine is cooled sufficiently.

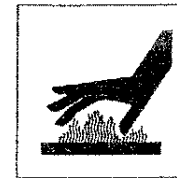

### ⚠ CAUTION

**Battery**

■ Battery generates flammable gases.

Improper handling may lead to explosion or serious injury.

\* For maintenance of the machine, disconnect the cable on the ground side.

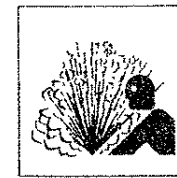



**⚠ CAUTION**

**Sign for maintenance**

- \* During checking or maintenance, be sure to put up a sign "Under maintenance" at a conspicuous place such as the starter switch to prevent the machine from being operated by other persons.

**⚠ CAUTION**

**Safety clothes**

- \* During checking or maintenance, be sure to put on suitable clothes and protectors.
- \* Do not put on baggy clothes, necklace, etc., because they are easily caught by projections which may cause injuries.

**⚠ CAUTION**

**Handling of waste liquid**

- \* Waste liquid from the machine should be received in a vessel.
- \* Do not dispose of waste liquid recklessly, as it causes environment pollution.  
Do not throw it on the ground or in rivers, lakes, sea, etc.
- \* Lubrication, fuel, cooling water (coolant) and other harmful objects such as filter, battery etc., should be disposed of according to the related regulations.

## 8-1 Maintenance schedule

50 hours: Checking/first 50hours

- \* Replacement of engine oil
- \* Replacement of engine oil filter cartridge
- \* Drain the fuel tank

100 hours: Checking/every 100 hours

- \* Cleaning of air cleaner element
- \* Check of fan belt
- \* Replacement of engine oil
- \* Cleaning of fuel filter element

200 hours: Checking/every 200 hours

- \* Replacement of engine oil filter cartridge

400 hours: Checking/every 400 hours

- \* Check on battery gravity
- \* Replacement of fuel filter element

500 hours: Checking/every 500 hours

- \* Replacement of air cleaner element
- \* Cleaning of radiator

1000 hours: Checking/every 1000 hours

- \* Cleaning inside of fuel tank
- \* Adjust fuel injection nozzle

2000 hours: Checking/every 2000 hours

- \* Measure the engine compression pressure
- \* Check the valve clearance
- \* Replacement of radiator water(if LLC is used)
- \* Check on nylon and rubber hose
- \* Checking for terminal and connection of the circuit.

Other Checks and Maintenance

- \* Check on lining

On the engine system, main checking items only are shown in this manual.  
For details, refer to the instruction manual for the engine furnished separately.

## 8-2 Checking/first 50 hours

### (1) Replacement of engine oil

Replace the engine oil at 50 hours only first time and every 100 hours after second time.

- ① Remove the engine oil drain plug and discharge oil completely. It can be discharged easily when the engine is warm.
- ② After engine oil is discharged, tighten the plug firmly.
- ③ Charge new engine oil from the oil filler until it reaches the notched line of the "H" on the dipstick.
- ④ After engine oil is supplied, run the engine for a few minutes. Check that oil is supplied to the level between H and L.

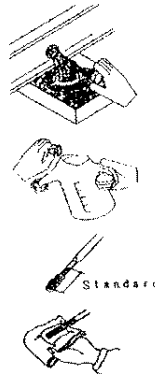

### (2) Replacement of engine oil filter cartridge

Replace the engine oil filter cartridge at 50 hours only first time and every 200 hours after second time.

Remove the drain plug and discharge oil completely in advance.

- ① Remove the cartridge using filter wrench.
- ② Insert the new cartridge.
- ③ Screw in the cartridge by hand. Once the gasket comes into contact with the face of the seal, tighten the cartridge using the filter wrench.
- ④ Run the engine for a while and check to see if there are any oil leakages. Stop the engine. After the engine has stopped for about 10 minutes, check the oil level gauge. If there is a shortage of oil, refill the oil.

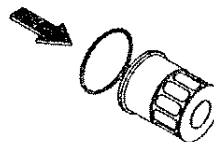

- Parts number of oil filter cartridge  
parts number

06020 41173

### (3) Drain the fuel tank

### 8-3 Checking/every 100 hours

#### (1) Cleaning of air cleaner element

— Dry dust clings on element —

Remove the air cleaner element and clean the element with dry and clean compressed air.

— Carbon and oil clings on element —

- ① Use a special element cleaner detergent.
- ② Soak the dirty air cleaner element in a solution of water and special element for about 15 minutes.
- ③ Rinse the air cleaner element using distilled water and let it dry in a place that is exposed to wind.

\* While it is being cleaned, check the element for any damage. Replace if necessary.

\* Before installing the air cleaner, wipe off dirt on the element cover.

\* When insert the element, insert the element completely pressing equal edge of element.

● Parts number of air cleaner cartridge

parts number

\* 06020 46335

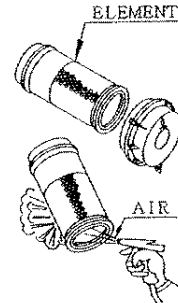

#### (2) Checking of fan belt

Refer to the instruction manual for the engine furnished separately.

#### (3) Replacement of engine oil

Refer to 「8-2.(1) Replacement of engine oil See p.39」 .

#### (4) Cleaning of fuel filter element.

- ① Turn the fuel filter cock to the close position. Remove the ring screw and take out the filter cup and element.
- ② Rinse the element using diesel fuel and also, clean the inside of the filter cup using diesel fuel.
- ③ After leaning, fit the fuel filter back to its original position. Make sure when the fuel filter is being refitted that it is not overly dusty.

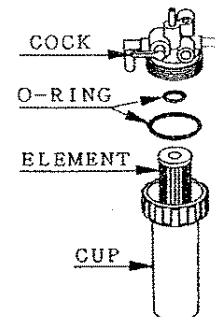

#### 8-4 Checking/every 200 hours

Checking/every 100 hours is also required.

##### (1) Replacement of engine oil filter cartridge.

Refer to 「8-2.(2) Replacement of engine oil filter cartridge See p.39」

#### 8-5 Checking/every 400 hours

Checking/every 100 and 200 hours is also required.

##### (1) Check on battery gravity.

Measure the battery gravity if there is a suspicion that battery leakage has occurred especially where there have been instances where the machine would not start.

The relationship between Battery Gravity and Battery Charging at 20 °C.

Battery Gravity	Battery Charging
Over 1.28	Over charged(need adjustment)
1.25 — 1.28	Optimal charging
1.24 — 1.25	Average
Below 1.24	Low charged(need adjustment)

In determining the specific gravity at a temperature other than 20 °C, use the following formula:

$$S_{20} = S_t + 0.0007(t - 20)$$

where  $S_{20}$  : is the calculated specific gravity at 20 °C.

$S_t$  : is the measured specific gravity

$t$  : is the battery solution temperature reading.

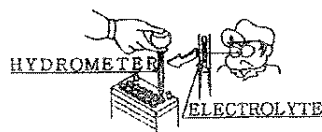

##### (2) Replacement of fuel filter element.

- ① Turn the fuel filter cock to the close position. Remove the ring screw and take out the filter cup and element.
- ② After replacement, fit the fuel filter back to its original position. Make sure when the fuel filter is being refitted that it is not overly dusty.

- Parts number of fuel filter element  
parts number

06020 42174

### 8-6 Checking/every 500 hours

#### (1) Replacement of air cleaner element

The element should be replaced referring to "Cleaning of air cleaner element" (See p.40) every 500 hours or 2 years.

In situations where the generator has not been operated for 500 hours or more, as a general rule, the air cleaner will need to be replaced after it has been cleaned 6 times.

#### (2) Cleaning of radiator

When the fin or tube is blinded, it should be cleaned with steam or running water. Do not use a high pressure washer to prevent damage to the fin and tube.

### 8-7 Checking/every 1000 hours

#### (1) Cleaning inside of fuel tank

Drain the fuel in the fuel tank completely, and wash out deposits and water collected inside the tank.

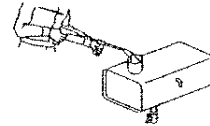

#### (2) Adjust fuel injection nozzle

### 8-8 Checking/every 2000 hours

#### (1) Measure the engine compression pressure

#### (2) Check the valve clearance

#### (3) Replacement of radiator water (if LLC is used)

#### (4) Check on nylon and rubber hose

Check on the nylon and rubber hose whether they are hardened or deteriorate.

Contact distributor or our office to replace the nylon hose and rubber hose, if necessary.

#### (5) Checking for terminal and connection of the circuit.

Check for main and sub circuit whether there are no abnormality such as loosening, corrosion and burning, etc.

### 8-9 Other Checks and Maintenance

#### (1) Check on lining

Check on the lining whether it deteriorates greatly, or it is stained by clinging of oil or the like, or it is removed. Contact distributor or our office to replace the lining, if necessary.

8-10 Table of periodical maintenance and checking

◇:Check or Clean ○:Replacement ☆:Only first time

List of maintenance and inspection	daily	first 50h	every 100h	every 200h	every 400h	every 500h	every 1000h	every 2000h
Checking on for water and oil leakage	◇							
Check for looseness of pipe connection and signs of wear	◇							○
Check for looseness of wiring connections and signs of wear	◇							
Checking on meters and warning lamps	◇							
Checking on oil level and stain of oil	◇							
Checking on cooling water	◇							
Checking on fuel	◇							
Drain the fuel tank		◇						
Checking on battery acid level	◇							
Replacement of engine oil		☆	○					
Replacement of engine oil filter		☆		○				
Cleaning on air cleaner element			◇					
Checking on fan belt			◇					
Cleaning of fuel filter element			◇					
Replacement of fuel filter element			◇		○			
Checking on battery gravity					◇			
Cleaning of radiator						◇		
Replacement of air cleaner element						○		
Adjust fuel injection nozzle							◇	
Cleaning inside of fuel tank							◇	
Measure the engine compression pressure								◇
Inspection of engine valve clearance								○
Replacement of radiator water								○
Checking on rubber suspension								○
Replacement of nylon and rubber hose								◇

Engine

※ Contact distributor or our office.

In detail, please refer to "Engine Instruction Manual" furnished separately.

## 9. Troubleshooting

### **⚠ WARNING**

**MOVING PARTS can cause severe injury.**

■ Rotary unit which moving parts at a high speed is located in the machine.

Care should be taken during operation.

\* When the machine needs checking or maintenance, be sure to stop it in advance.



### **⚠ WARNING**

**ELECTRIC SHOCK can kill.**

■ High voltage units are located in the machine. Care should be taken during operation.

\* When the machine needs checking or maintenance, be sure to stop it in advance.



### **⚠ CAUTION**

**HOT PARTS can burn skin.**

■ High temperature parts are located in the machine. Care should be taken during operation.

\* When the machine needs checking or maintenance, be sure to stop it in advance.

\* Even after the machine stops, the inside of the bonnet is still hot. Wait until the engine is cooled sufficiently.



### **⚠ CAUTION**

**Battery**

■ Battery generates flammable gases.

Improper handling may lead to explosion or serious injury.

\* For maintenance of the machine, disconnect the cable on the ground side.

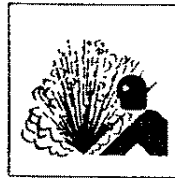



Phenomenon		Assumed cause	Action
Engine will not start up	Cell motor will not run or revolving speed is low	Discharged battery	Charge or replace
		Detached or loosened or corroded battery terminal	Repair
		Fuse blow	Replace
		Improper starter switch	Replace
		Improper starter	Replace
		Broken lead wire	Repair
	Cell motor runs	Fuel shortage	Supply
		Blinded fuel filter	Replace filter
		Air in fuel system	Remove
		Air in fuel system	Remove
Speed will not rise	Blinded fuel filter	Replace filter	
	Compression failure	Repair engine	
	Blinded air cleaner	Replace element	
	Oil shortage	Supply	
Engine stop by oil failure	Oil pressure switch failure	Replace	
	Blinded oil filter	Replace filter	
	Cooling water shortage	Supply	
Over heat (water temperature)	Fan belt looseness	Adjust	
	Blinded core of radiator	Cleaning	
	Engine thermostat failure	Repair	
	Voltmeter failure	Replace	
Voltmeter will not operate	AVR failure	Contact distributor or our office	
	Burned ZNR		
	Quenched residual magnetism		
	Burned rotary rectifier		
	Disconnected rotor wiring		
	Burned generator wiring		
Rated voltage will not be reached	Voltmeter failure	Replace	
	AVR failure	Contact distributor or our office	
	VR failure		
	Burned rotary rectifier		
	Burned ZNR		
	Burned generator wiring		
Low speed	Increase		
Voltage goes too high	Voltmeter failure	Replace	
	AVR failure	Contact distributor or our office	
	VR failure		
Applied load causes load voltage drop	Burned rotary rectifier	Contact distributor or our office	
	AVR failure		
	Burned main field, exciter field wiring		
	Unbalanced load	Balance	

## 10. Long-term storage

When the machine is to be stored for a long period of time, choose a cool place free from moisture and dust, and observe the following points.

- (1) Remove dirt clung the machine and clean it thoroughly.  
If painting is peeled off, it should be repaired.
- (2) Remove the battery from the machine.  
The battery should be charged completely before it is stored.  
-Battery is discharged of itself. Recharge it once a month.
- (3) If any defects are found, check and repair the machine so that it can be used for future operation.
- (4) For details of handling the engine, refer to the instruction manual for the engine provided separately.

### **⚠ CAUTION**

#### **Stacking**

■ Improper stacking of machines may cause falling or dropping accidents.

When stacking other machines on this machine, be sure to observe the following points.

- \* Check that the bonnet of the machine is free from damage and that the fixing bolts are not loosened and missing.
- \* Put the machine horizontally on a solid foundation which withstands the weight of stacked machines.
- \* Machines can be stacked up to 2 stages. The weight and size of stacked machines should be less than those of this machine.
- \* Using square timbers as shown right, put each machine making sure that the weight is even.

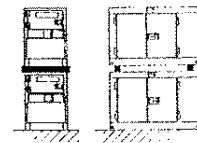

■ Do not operate the machines in the state of stacking to prevent falling or dropping accidents.

## 11. Service data

### 11-1 Specifications (Standard)

MODEL		DCA-13ESK-DA	DCA-15ESK-DA	DCA-25ESK-DA
A C G E N E R A T O R	MODEL	DF-0140K	DF-0170K	DF-0270K
	FREQUENCY	50 Hz / 60 Hz		
	RATED OUTPUT	10.5 kVA /13kVA	12.5 kVA /15kVA	20.0 kVA /25kVA
	RATED VOLTAGE	380. 400 V (200.220V)		
	RATED CURRENT	16.0A (34.1A)	19.0A (39.4A)	30.4A (65.6A)
	POWER FACTOR	0.8		
	NO.OF POLES	4		
	SPEED	1500 mm <sup>-1</sup> / 1800 mm <sup>-1</sup>		
	INSULATION	class H		
	MANUFACTURE	KUBOTA		
E N G I N E	MODEL	D1403-EB	D1703-EB	V2203-EB
	TYPE	4-cycle, water-cooled, diesel engine, swirl chamber type		
	NO.OF CYLINDERS BOREXSTROKE(mm)	3 - 80 X 92.4	3 - 87 X 92.4	4 - 87 X 92.4
	TOTAL DISPLACEMENT	1.393 L	1.647 L	2.197 L
	RATED OUTPUT (1500/1800min <sup>-1</sup> )	10.2 / 12.4 kW	12.4 / 14.7 kW	18.4 / 23.7 kW
	BATTERY (DOMESTIC STANDARD)	Yuasa N 50 Z		
	FUEL	DIESEL FUEL ASTM No.2 or equivalent		
	FUEL TANK CAP.	Approx. 62 L		
	ENGINE OIL *1	OVERALL	Approx. 5.6 L	
	COOLANT QUANTITY*2	OVERALL	Approx. 6.4 L	
S E T	LENGTH OVERALL	1390 mm		1540 mm
	WIDTH OVERALL	650 mm		
	HEIGHT	900 mm		
	DRY WEIGHT	503 kg	516 kg	591 kg
	TOTAL WEIGHT	571 kg	584 kg	664 kg

The above specifications and set dimensions are subject to change.

\*1 Overall of engine oil contains filter.

\*2 Overall of coolant quantity contains reserve tank.

Dry weight : This weight does not contain the cooling water engine oil and fuel.

Total weight : This weight contains the cooling water, engine oil and fuel.

11-2 AC generator specifications (for custom voltage)

DCA-13ESK

Frequency (Hz)	50Hz						
Rated output (kVA)	10.5						
Rated voltage(V)	190	200	220	380	400	415	440
Rated current(A)	31.9	30.3	27.6	16.0	15.2	14.6	13.8

Frequency (Hz)	60Hz							
Rated output (kVA)	13							
Rated voltage(V)	190	200	220	240	380	400	440	480
Rated current(A)	39.5	37.5	34.1	31.3	19.8	18.8	17.1	15.6

DCA-15ESK

Frequency (Hz)	50Hz						
Rated output (kVA)	12.5						
Rated voltage(V)	190	200	220	380	400	415	440
Rated current(A)	38.0	36.1	32.8	19.0	18.0	17.4	16.4

Frequency (Hz)	60Hz							
Rated output (kVA)	15							
Rated voltage(V)	190	200	220	240	380	400	440	480
Rated current(A)	45.6	43.3	39.4	36.1	22.8	21.7	19.7	18.0

DCA-25ESK

Frequency (Hz)	50Hz						
Rated output (kVA)	20						
Rated voltage(V)	190	200	220	380	400	415	440
Rated current(A)	60.8	57.7	52.5	30.4	28.9	27.8	26.2

Frequency (Hz)	60Hz							
Rated output (kVA)	25							
Rated voltage(V)	190	200	220	240	380	400	440	480
Rated current(A)	76.0	72.2	65.6	60.1	38.0	36.1	32.8	30.1

11-3 Outline drawing  
DCA-13ESK

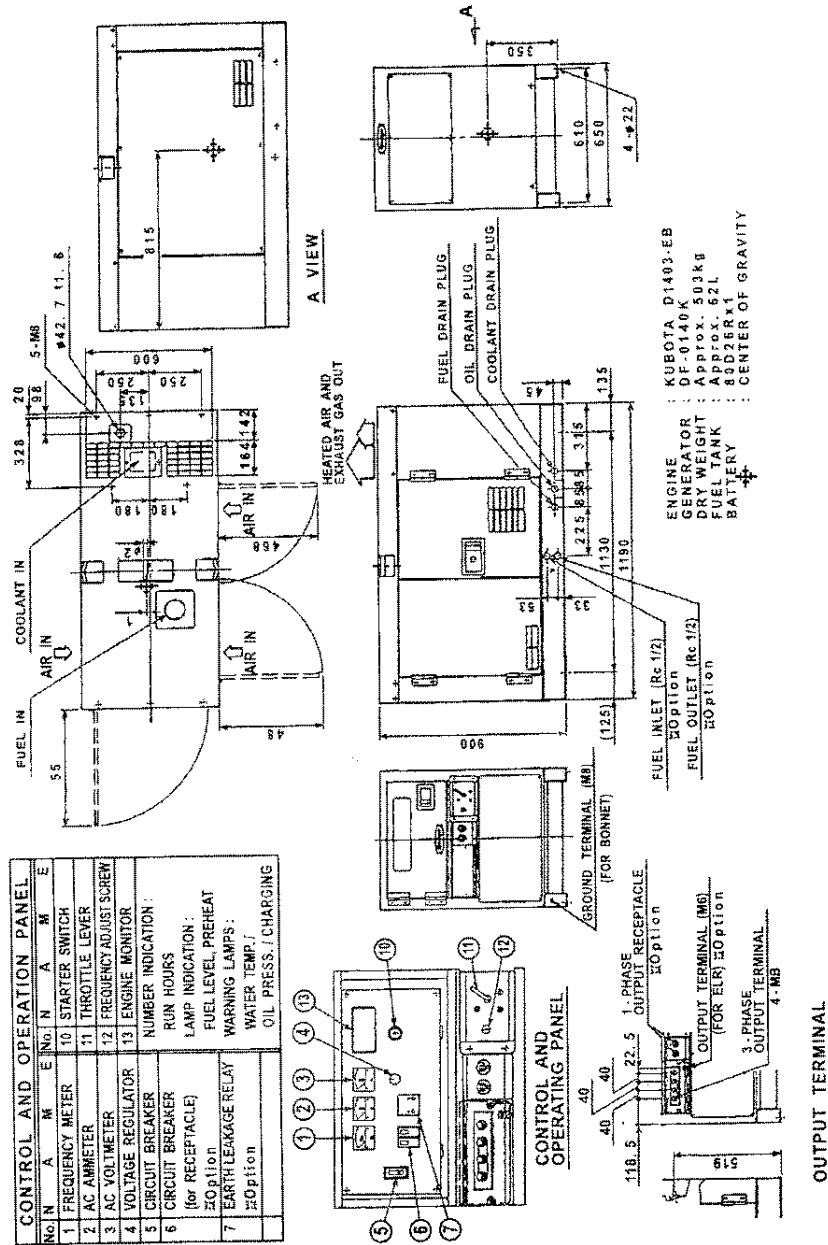

# DCA-15ESK

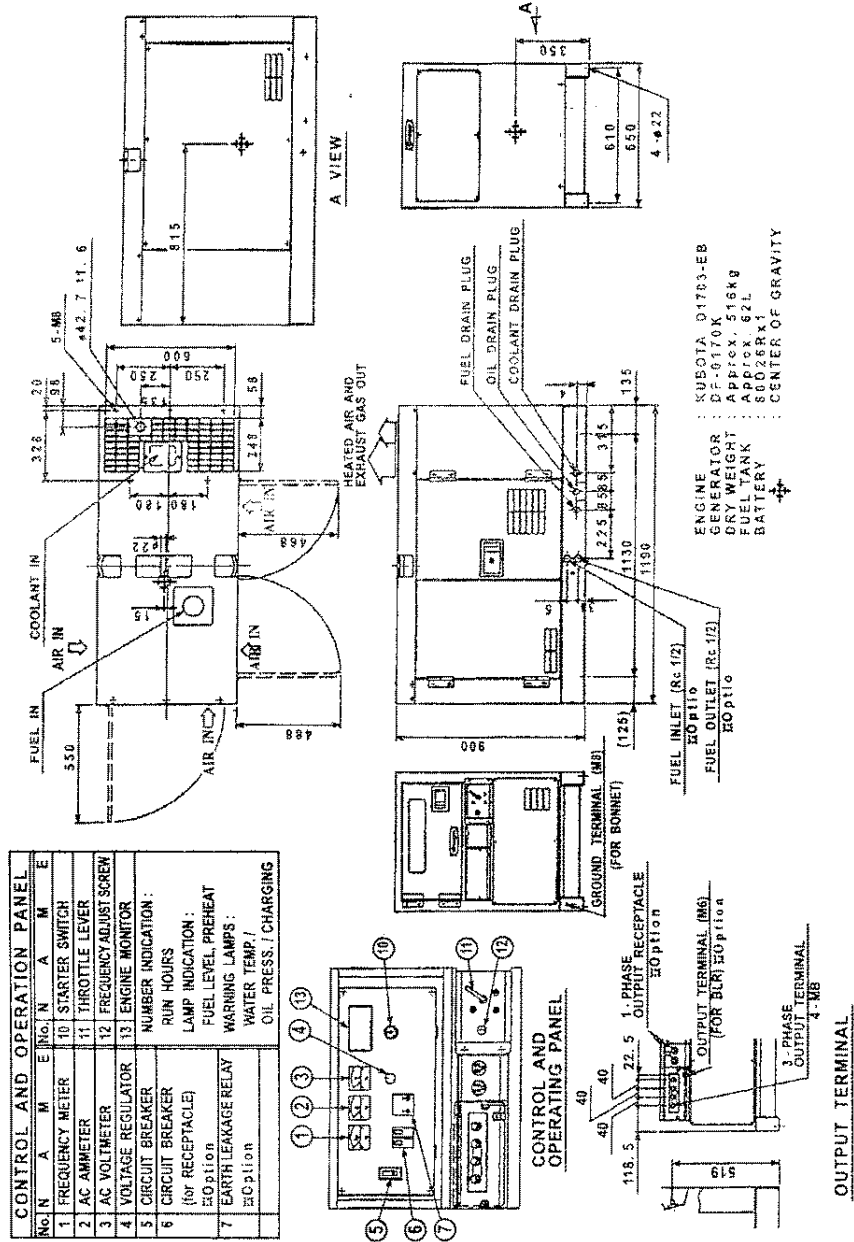

# DCA-25ESK

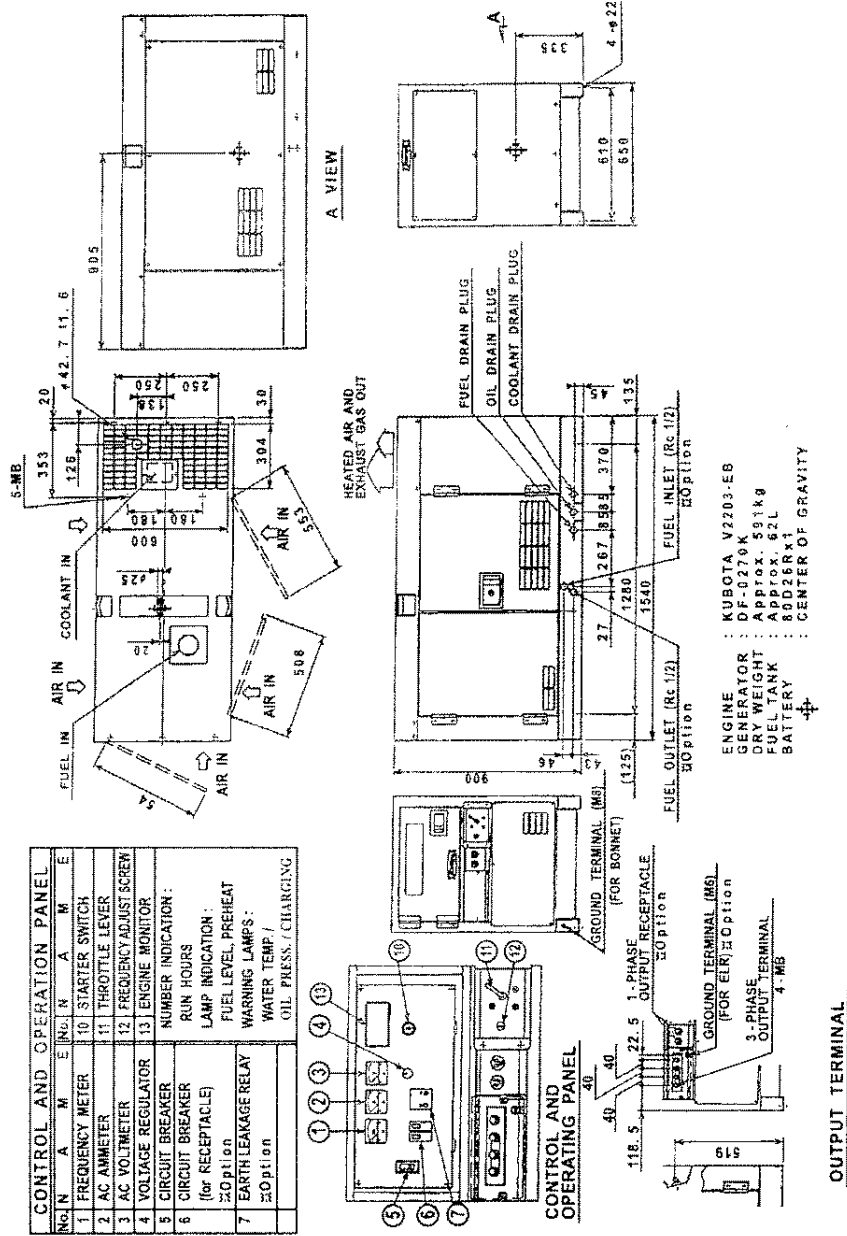

# 11-4 Generator connection diagram DCA-13, 15ESK

SYMBOL	PARTS NAME
V	AC Voltmeter
A	AC Ammeter
F	Frequency Meter
CB 1	Circuit Breaker (for 3-Phase Output)
22	Birth Leakage Relay
C	Condensator
CON1	1-Phase Output Receptacle
2	Automatic Voltage Regulator
VR	Voltage Regulator
R	Resistor
⊕ (V,W,O)	Output Terminal
⊕ J,K	Combination Terminal
Re	Resistor
CBZ 3	Circuit Breaker (for Receptich)
⊕	Ground Terminal (for BR)

⊕: Option

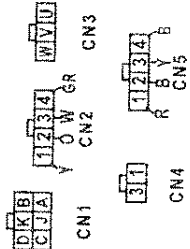

CONNECTOR ARRANGEMENT  
(WIRING VIEW)

WIRE SIZE	COLOR	WIRE COLOR
3	3mm <sup>2</sup>	B BLACK
3.5	3.5mm <sup>2</sup>	R RED
7	7mm <sup>2</sup>	L BLUE
7.5	8.75mm <sup>2</sup>	W WHITE
		Y YELLOW
		LB BROWN
		G GREEN
		LG LIGHT GREEN
		V VIOLET
		O ORANGE

NO. MARK: 1. 25mm<sup>2</sup>

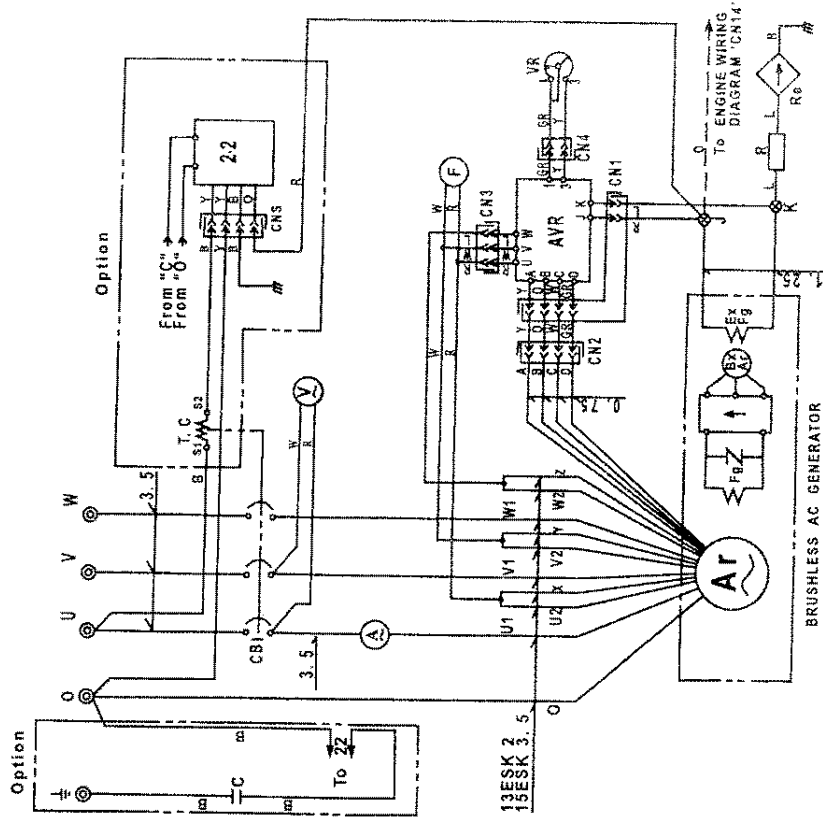



# DCA-25ESK

SYMBOL	PARTS NAME
V	AC Voltmeter
A	AC Ammeter
F	Frequency Meter
CB 1	Circuit Breaker (for 3-Phase Output)
22	Anti-Leakage Relay
C	Condenser
CON1	1-Phase Output Receptacle
2	Current Transformer
CT	Automatic Voltage Regulator
VR	Voltage Regulator
R	Resistor
R	Rectifier
⊕ J, K	Combination Terminal
⊖ CBZ, 3	Circuit Breaker (for Receptacle)
⊖ ⊕	Ground Terminal (for BLR)
⊖ ⊕/V/W/O	3-Phase Output Terminal

⊕: Option

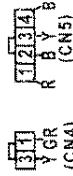
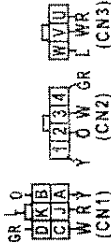

CONNECTOR ARRANGEMENT  
(WIRING VIEW)

WIRE SIZE	WIRE COLOR	COLOR CODE
5.5	5.5mm <sup>2</sup>	R RED
3.5	3.5mm <sup>2</sup>	W WHITE
2.5	2.5mm <sup>2</sup>	Y YELLOW
0.75	0.75mm <sup>2</sup>	LG LIGHT GREEN
		OR ORANGE
		GR GRAY
		BL LIGHT BLUE
		BR BROWN
		L BLUE
		GR GREEN
		LB LIGHT BLUE
		Y YELLOW
		W WHITE
		R RED

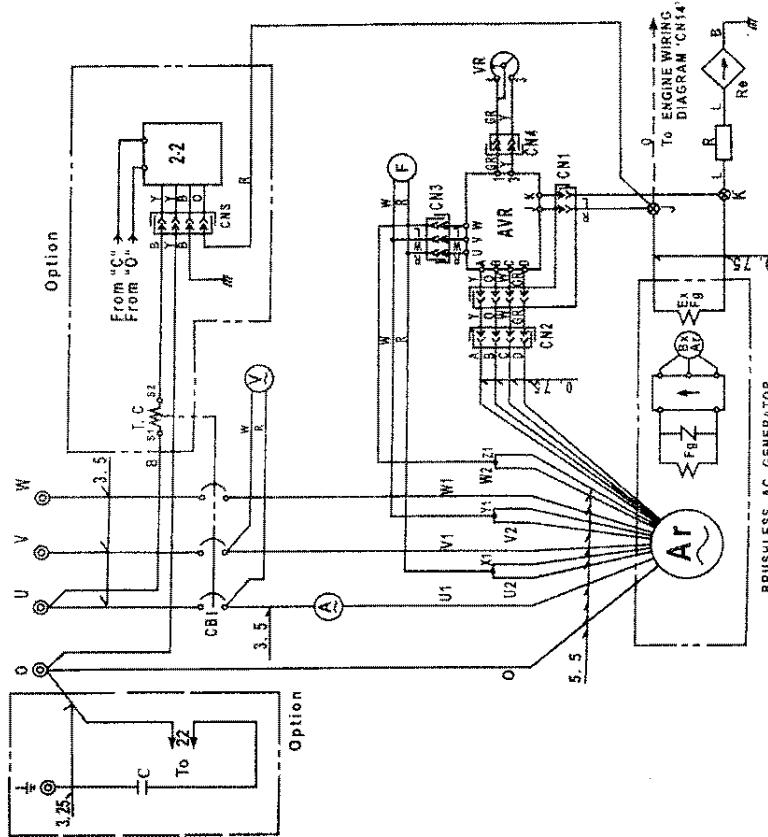

# DCA-13ESK [200V class]

SYMBOL	PARTS NAME
V	AC Voltmeter
A	AC Ammeter
F	Frequency Meter
CB 1	Circuit Breaker (for 3-Phase Output)
22	Earth Leakage Relay
C	Condenser
CON 1, 2	1-Phase Output Receptacle
CT	Current Transformer
AVR	Automatic Voltage Regulator
VR	Voltage Regulator
R	Resistor
Re	Rectifier
J, K	Combination Terminal
CB 2, 3	Circuit Breaker (For-Receptacle)
⊕	Ground Terminal (for ELR)
⊕ J, V, W, O	3-Phase Output Terminal

□ - : Option

⊕	⊕	⊕	⊕
W R Y GR	W R Y GR	W R Y GR	W R Y GR
(CN 1)	(CN 2)	(CN 3)	(CN 3)

⊕	⊕	⊕	⊕
R B Y B	R B Y B	R B Y B	R B Y B
(CN 4)	(CN 5)	(CN 5)	(CN 5)

CONNECTOR ARRANGEMENT  
(WIRING VIEW)

WIRE SIZE	WIRE COLOR	COLOR CODE
3 1.5mm <sup>2</sup>	B BLACK	R RED
3 2mm <sup>2</sup>	L BLUE	W WHITE
0.75 0.75mm <sup>2</sup>	BR BROWN	Y YELLOW
	G GREEN	LB LIGHT BLUE
	GR GRAY	LG LIGHT GREEN
	V VIOLET	O ORANGE
NO MARK 1.25mm <sup>2</sup>	P PINK	

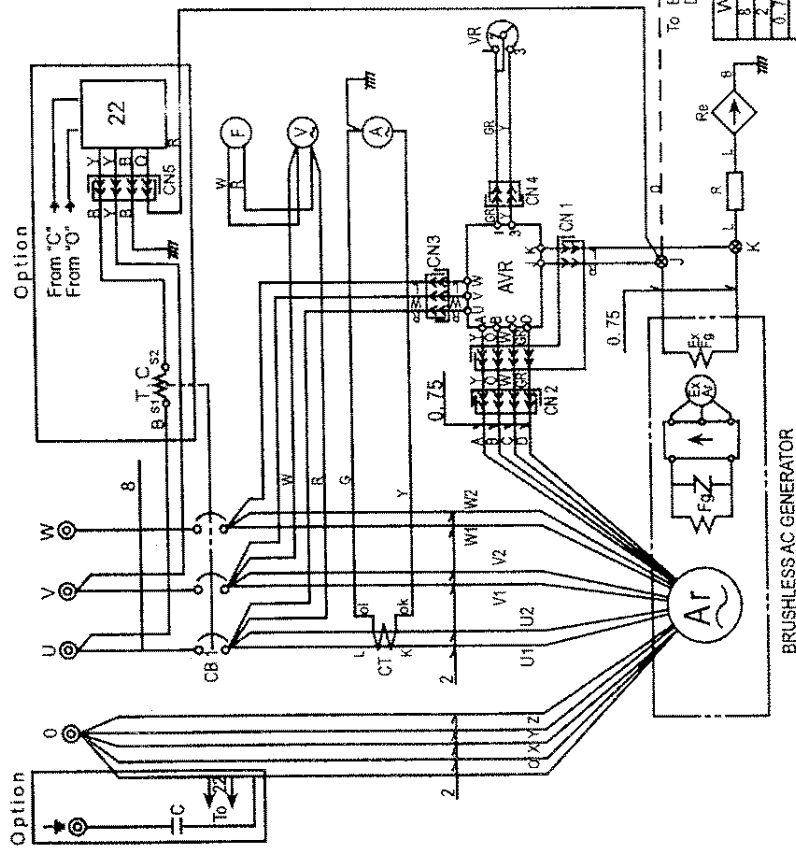

# DCA-25ESK [200V class]

SYMBOL	PARTS NAME
V	AC Voltmeter
A	AC Ammeter
F	Frequency Meter
CB 1	Circuit Breaker (for 3-Phase Output)
22	Earth Leakage Relay
C	Condenser
CON 1, 2	1-Phase Output Receptacle
CT	Current Transformer
AVR	Automatic Voltage Regulator
VR	Voltage Regulator
R	Resistor
Re	Rectifier
J, K	Combination Terminal
CB 2, 3	Circuit Breaker (For-Receptacle)
⊕	Ground Terminal (for ELR)
⊕ U, V, W, 0	3-Phase Output Terminal

⊕ - : Option

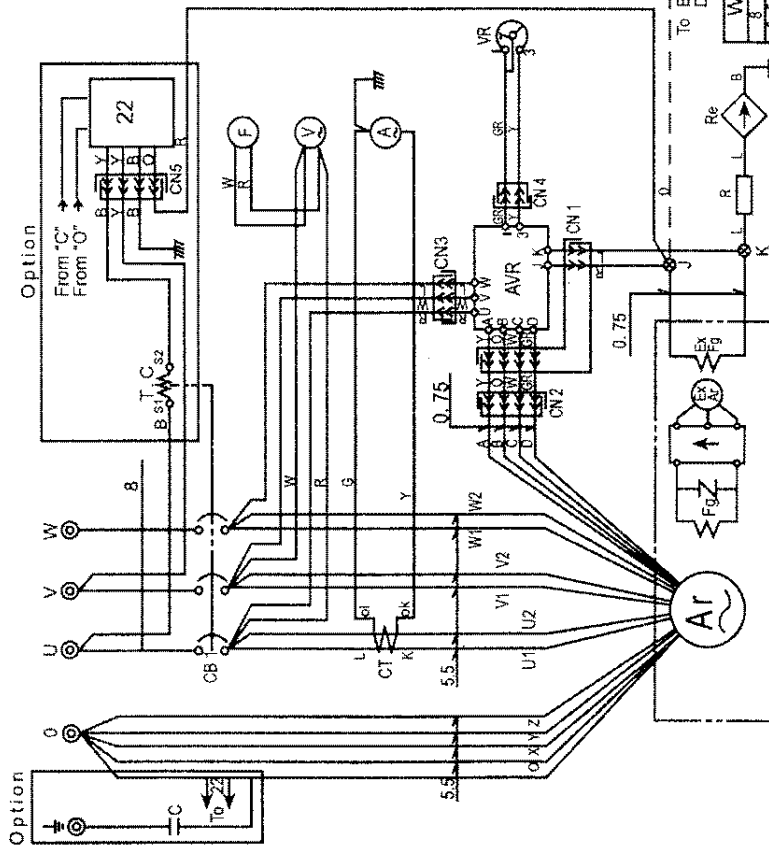

## CONNECTOR ARRANGEMENT (WIRING VIEW)

GR 1, 0	[A][B][C][D]	[W][V][U]
[C][L][J][A]	W R Y GR	W R A
W R Y	(CN 2)	(CN 3)
[W][V][U]	[1][2][3][4]	[5]
W R Y	R S Y B	
(CN 4)	(CN 5)	

WIRE SIZE	WIRE COLOR	WIRE COLOR
8 : 2mm <sup>2</sup>	B BLACK	R RED
3, 5 : 3.5mm <sup>2</sup>	L BLUE	W WHITE
5, 5 : 5.5mm <sup>2</sup>	BR BROWN	Y YELLOW
2 : 2mm <sup>2</sup>	G GREEN	LB LIGHT BLUE
0.75 : 0.75mm <sup>2</sup>	GR GRAY	LG LIGHT GREEN
	V VIOLET	O ORANGE
	P PINK	

# 11-5 Engine wiring diagram DCA-13, 15, 25ESK

WIRE SIZE	WIRING COLOR CODE	SYMBOL	COLOR
38: .38 ml	B	R	RED
5: 5 ml	BL	W	WHITE
3: 3 ml	L	W	WHITE
2: 2 ml	BR	Y	YELLOW
1.25: 1.25 ml	G	LB	LIGHT BLUE
	GR	LG	LIGHT GREEN
	V	O	VIOLET
NO MARK: 0.75 ml	P		PINK

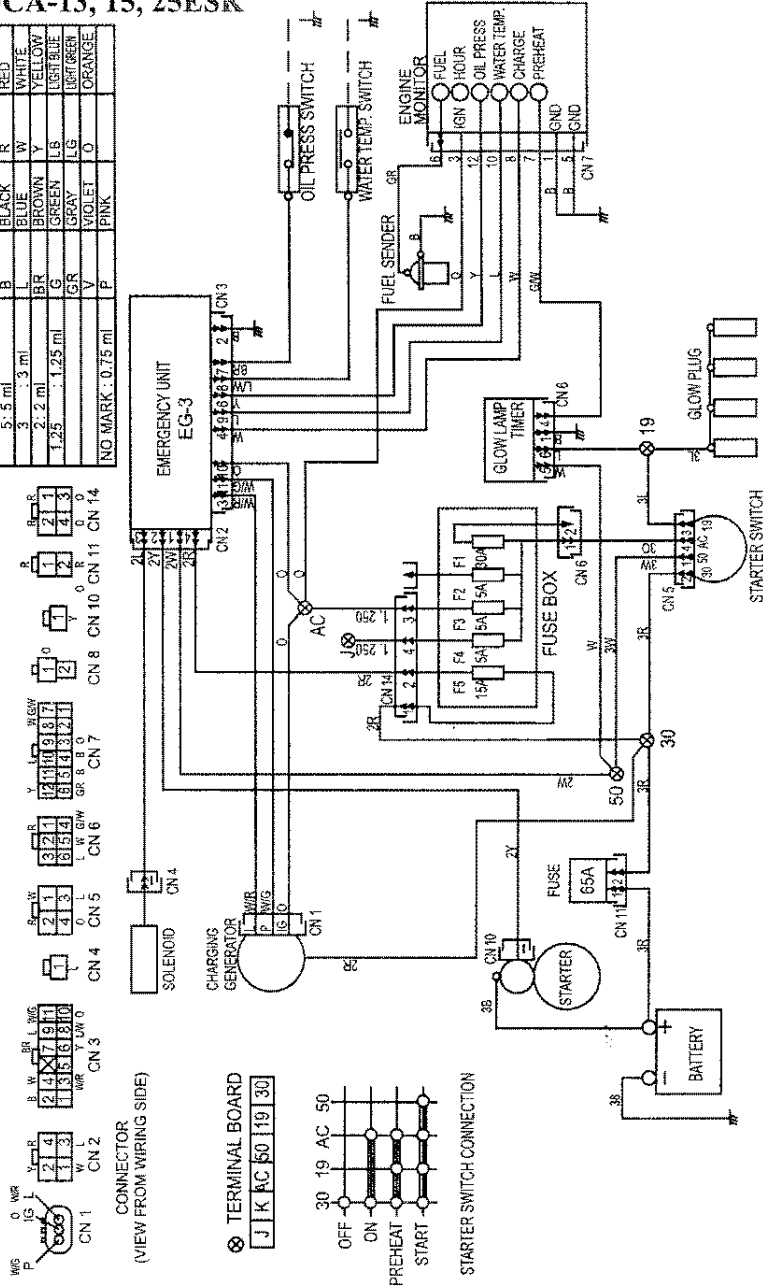

## 12. Options instruction manual

If equipment for the option device to the machine after the purchase is required, contact distributor or our office.

If the machine is modified on your own, the warranty of manufacturer will become invalid.

### 12-1 Earth leakage Relay

#### ⚠ WARNING

**ELECTRIC SHOCK by leak can kill.**

■ Improper grounding may lead to death due to electric shock. Because the device for leakage protection does not operate effectively.

\* Grounding terminal for the earth leakage relay, case grounding terminal and case of the load are grounded.



#### (1) Description of the device

The machine is provided with an earth leakage relay to detect any leakage produced due to such trouble as insulation failure of the load during operation and to cut off the circuit for protection against any accident such as electrocution resulting from the trouble.

The current sensitivity of this relay is 30 mA.

Improper handling of the relay may lead to unsafe condition in comparison with that does not use the relay.

To ensure further safety, install a leakage relay for each load at the position near the load.

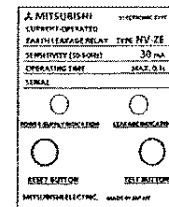

#### (2) Grounding

Ground as following to operate the earth leakage relay certainly.

##### ■ Grounding of the machine

Ground the grounding terminal for earth leakage relay and case grounding terminal according to the below.

① Grounding of the grounding terminal for earth leakage relay  
If grounding described below does not comply with the local rule, stricter of the two shall apply.

Use the grounding wire which sectional area is  $5.5\text{mm}^2$  or larger. Usually it is possible that using attached grounding rod. But if grounding resistance is over  $100\ \Omega$ , provide the grounding rod which surface area contacted the ground is large.

② Grounding of the case grounding of the machine

Refer to 「4-3(1) Case grounding of the machine See p.21」

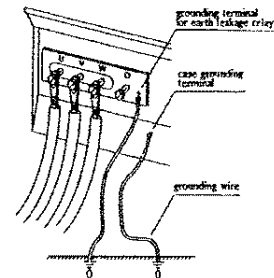

■ Grounding of the load equipment

As in the case of the machine, execute grounding work on the load equipment case. Provide the grounding rod to satisfy the grounding resistance which conforms to the local rule.

[Note] :

The installation of a leakage relay on the machine can not become a reason for elimination of the need for the load side grounding.

The load side grounding is indispensable for earliest possible detection of any leakage caused in the generator. The absence of such grounding requires any leakage to be detected by current flowing through the human body and is very dangerous because the sensitivity of leakage relay provided on the machine is not sufficient for detection of such current.

■ Precaution in grounding

Refer to 「4-3 (3) Precaution in grounding See p.20」

■ Operation check

For safety reasons, check on the operation of the leakage relay at the startup of the machine according to the procedure described below:

- ① Startup the machine according to 「5-2 Startup See p.25」 .
- ② Make sure that all breakers of the load side are "OFF".
- ③ Set the circuit breaker to "ON".
- ④ Press the TEST button on the leakage relay. If this causes the LEAK lamp (red) on the leakage relay to go on and the breaker to be activated, the leakage relay can be regarded as operating normally.
- ⑤ Press the RESET button and return the breaker to the "OFF" position. This allows the breaker to be turned to "ON" again.

\* The leakage relay, once it is activated, holds its activated state until the RESET button is pressed or the machine is stopped.

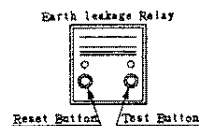

(3) Action for operation of the leakage relay

When the leakage relay is activated, then stop the engine and measure the insulation resistance several parts and repair the leak spot before restart the engine.