

INSTRUCTION MANUAL

DENYO

DIESEL GENERATING SETS

Before using, be sure to read this manual for the sake of safety.

Be sure to observe the items under symbol marks "⚠ WARNING"
and "⚠ CAUTION" for the sake of safety.

Always keep this manual at your machine for the sake of safety.

DCA-45SPI



DCA-60SPI

DCA-75SPI

FOREWORD

- * Your machine is a portable type diesel generating set.
(Specifications: See p.68)
- * Do not install, operate or repair this machine without reading this operating manual.
- * This generator set (machine) must be operated by a person having sufficient knowledge and skill for the sake of safety.

Notes on instruction manual

- * This instruction manual explains correct operation and maintenance of the machine to ensure its performance.
Incorrect handling of the machine may lead to a serious injury or decease.
Before using, be sure to read this manual carefully.
Particularly, the items under " Safety precautions" (See p. 1 to p. 10) ,
"  WARNING" and "  CAUTION" must be read thoroughly.
 - * Keep this manual in the case behind the rear door for future reference.
 - * Read the contents of the warranty card attached to the machine.
- If this manual becomes illegible by spot or damage, contact distributor or our office to get new manual.

- Contents -

1.	Safety Precautions	1
2.	Construction	11
2-1	Outline and part names	11
2-2	Operating panel, control panel and part names	12
2-3	Meters	13
2-4	Use of switches and controllers	18
3.	Transportation and installation	21
3-1	Transportation of machine	21
3-2	Installation of machine	22
4.	Connecting the load	24
4-1	Double voltage	24
4-2	Cables to be used	26
4-3	Connecting the load	27
4-4	Earth leakage relay and grounding	30
5.	Operation	33
5-1	Checking prior to operation	33
5-2	Startup	39
5-3	Handling during operation	42
5-4	Shutdown	43
5-5	Protection device	44
6.	Lubrication, cooling water and fuel	45
6-1	Engine oil	45
6-2	Cooling water	46
6-3	Fuel	46
7.	Handling of battery	47
7-1	Caution on battery charge	48
7-2	Connection of booster cable, and installation	49
8.	Periodical checking and maintenance	50
8-1	Maintenance schedule	53
8-2	Checking/first 50 hours	54
8-3	Checking/every 250 hours	56
8-4	Checking/every 500 hours	59
8-5	Checking/every 1000 hours	61
8-6	Table of periodical maintenance and checking	62
9.	Troubleshooting	63
10.	Long-term storage	67
11.	Service data	68
11-1	Specifications	68
11-2	AC generator specifications (for custom voltage)	69
11-3	Outline drawing	70
11-4	Generator connection diagram	73
11-5	Engine wiring diagram	76

1. Safety Precautions

In order to ensure safe operation, the following symbols are used for explanation of the machine operation.

The following symbols, found throughout this manual, alert you to potentially dangerous conditions to the operator, service personnel, or the equipment.

 **WARNING:** This symbol refers to a hazard or unsafe practice which can result in severe personal injury or death.

 **CAUTION:** This symbol refers to a hazard or unsafe practice which can result in personal injury or product or property damage.

[Note] : This symbols show handling precautions for effective operation and many years of satisfactory operation.

Some of the items shown by " CAUTION" may also cause death or serious injury.

Be sure to observe all the items, as they are important for safe operation.

- * If the machine is used by an outsider, you are requested to explain him correct handling and advise him to read this instruction manual carefully.
- * Do not modify the machine at your discretion, as it affects the safety, performance or the life of the machine.
- * If the machine is modified or it is used incorrectly against this manual or unauthorized parts are used, the warranty of manufacturer will become invalid.

Safety label

Safety labels are attached to the following positions of the machine.

- * Keep these safety labels clean at all times.
- * When safety labels are spoiled or lost, contact distributor or our office specifying the nameplate No. shown below and ask for new ones. Following numbers are for model 45SPI.

No.	Parts name	Parts number	No.	Parts name	Parts number
1	Safety instruction	B9211 0040	6	Warning : moving part	B9040 0040
2	Warning : exhaust gas	B9042 0000	7	Warning : fire accident	B9045 0000
3	Warning : output voltage	B9311 0050	8	Caution : high temp	B9040 0030
4	Warning : electric leakage	B9111 0040	9	Warning : radiator cap	B9041 0010
5	Warning : electrical shock	B9311 0060	10	Warning : house wiring	B9111 0030

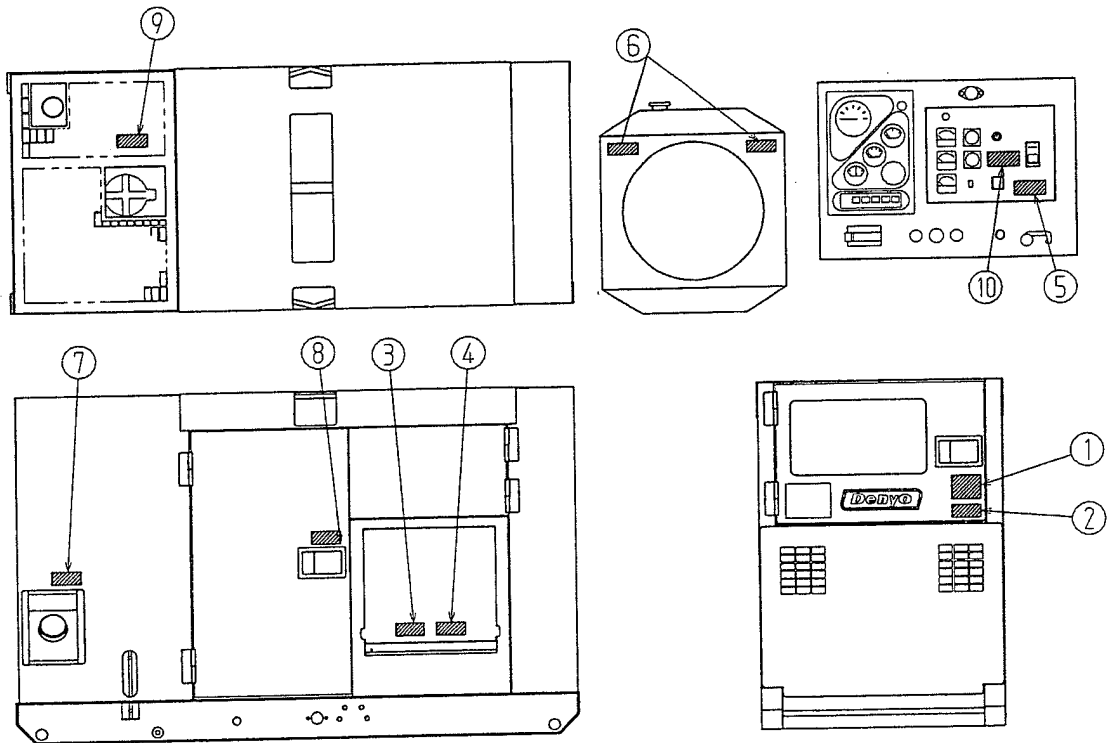

 **WARNING**

ENGINE EXHAUST can kill.

- Insufficient ventilation may lead to death due to lack of oxygen or poisoning by exhaust gases.
- * Do not use the machine in a place of poor ventilation or in a place where exhaust gases stays.
- * Do not use the machine indoors or in storehouse, tunnel, ship hold, tank, etc. of poor ventilation.
- * If it becomes necessary to use the machine in the above places, the exhaust pipe should be extended to a well ventilated place. In this case, use a ventilator to ensure proper ventilation.
- * Do not direct the exhaust outlet to nearby pedestrians and houses.

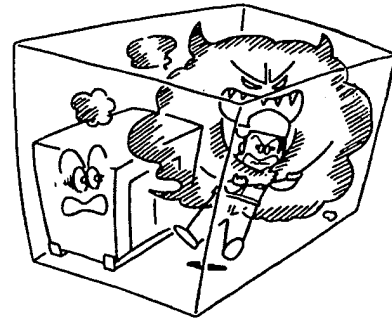
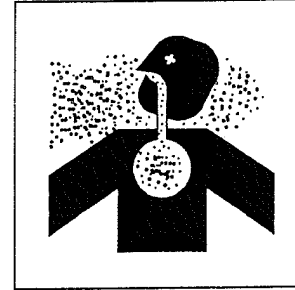



WARNING

ELECTRIC SHOCK can kill.

- Do not touch the output terminals during operation to prevent decease due to electric shock.

- * Never touch the output terminals during operation.

- If your hands or the machine are wet, it will result in a death or serious injury.

- * When a wiring work is required, be sure to turn OFF the circuit breaker and stop the machine.

- * Keep the output terminal cover closed and the terminal bolts tightened while the machine is running.

- * A low voltage is generated even when the machine is in low speed idle operation.

- Be sure to stop the machine completely.

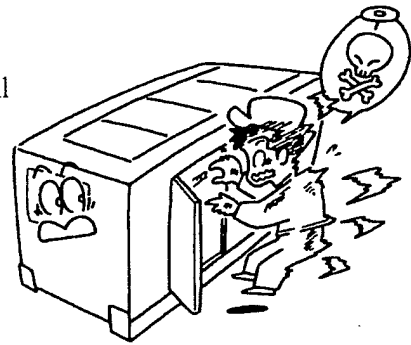

- Do not touch the electrical parts in the machine during operation, as it may lead to death due to electric shock.

- * Always close the control panel and tighten the fixing bolts before operating the machine.

- * Always close the side door and lock it before operating the machine.

- * When opening the control panel for voltage selection, etc., turn OFF the circuit breaker and stop the machine.

 **WARNING**

ELECTRIC SHOCK by leak can kill.

- Improper grounding may lead to death due to electric shock.

「4-4.(3) Grounding See p.31」

- * Be sure to execute the grounding of the machine and the load according to the local rule.



 **WARNING**

MOVING PARTS can cause severe injury.

- Rotary unit which runs at a high speed is located in the machine.

(Note that it is very dangerous if you touch it.)

- * Be sure to close the door and lock it during operation.
- * When the door needs to be opened during operation, do not get your hands and head in the machine to prevent them from being caught in the machine which may lead to injury.
- * When making check or maintenance of the machine, be sure to stop the machine in advance.

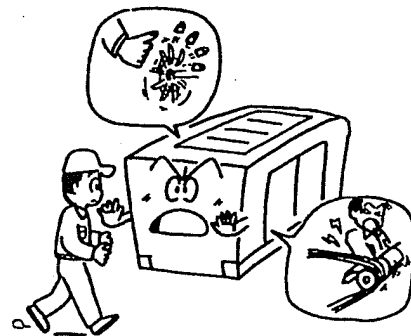
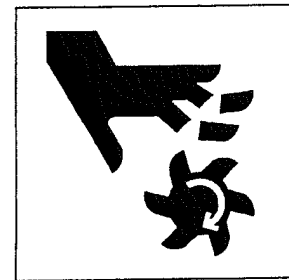

 **WARNING**

DIESEL FUEL can cause fire or explosion.

■ Fuel and oil are flammable. Incorrect handling results in danger of ignition or fire.

* When fuel needs to be supplied to the machine, be sure to stop the engine. Refrain from smoking.

Keep the machine away from fire.

* Do not leave flammable objects (paper, wood chips, etc.) and hazardous objects (oil, powder, etc.) near the machine.

* Wipe off spilt fuel and oil.

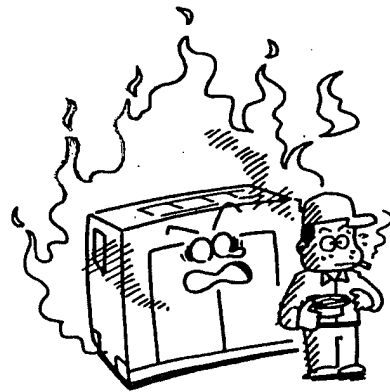
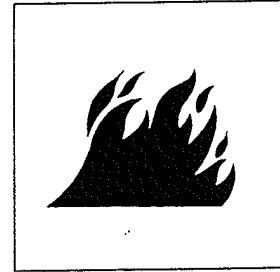

 **WARNING**

HOT COOLANT can cause severe scalds.

■ If the radiator cap is opened while the water temperature is high, steam or hot water will spout out.

* During operation or immediately after stopping the machine, do not open the radiator cap while the water temperature is high.

* When cooling water needs to be checked or supplied, wait until the engine is cooled (50 °C or less as measured with the water temperature gauge).

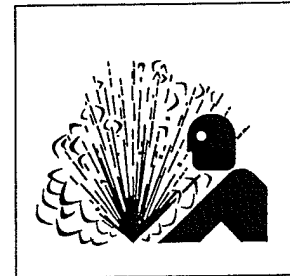

CAUTION

Stacking

- Improper stacking of machines may cause falling or dropping accidents. When stacking other machines on this machine, be sure to observe the following points.

- * Check that the bonnet of the machine is free from damage and that the fixing bolts are not loosened and missing.
- * Put the machine horizontally on a solid foundation which withstands the weight of stacked machines.

- * Machines can be stacked up to 2 stages.
The weight and size of stacked machines should be less than those of this machine.
- * Using square timbers as shown right, put each machine making sure that the weight is even.

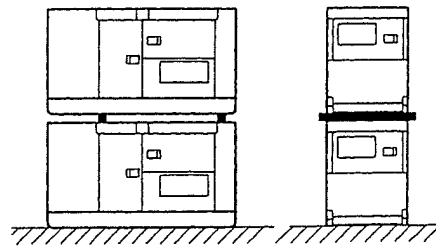

- Do not operate the machines in the state of stacking to prevent falling or dropping accidents.

CAUTION

HOT PARTS can burn skin.

- High temperature units are located in the machine. (Note that these units are very dangerous if they are used incorrectly.)

- * Be sure to close the door and lock it during operation.
- * If the door needs to be opened during operation, do not get your hands and head in the machine to prevent unexpected burns.
- * When making check or maintenance of the machine, be sure to stop the machine.
- * The bonnet is still hot even after the machine is stopped.

Be careful until the engine is completely cooled.

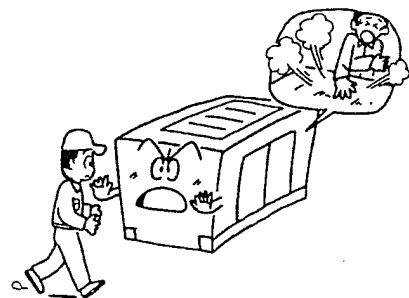
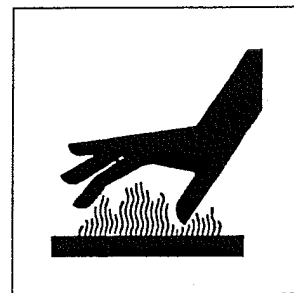

 **CAUTION**

BATTERY

- Battery generates flammable gases.
Improper handling may lead to explosion or serious injury.
- * Battery should be charged in a well ventilated location. Otherwise, flammable gases are accumulated which may be ignited and exploded.
- * When connecting a booster cable, do not jumper the terminals (+ and -). Otherwise, the flammable gases generated from the battery may be ignited and exploded by sparks.
- * For maintenance of the machine, disconnect the ground cable on the ground side.
- The battery acid is dilute sulfuric acid. Improper handling will cause unexpected burns.
- * When the battery acid gets on your clothes or skin, wash it out with a large volume of water immediately. If it gets in your eyes, wash with a large volume of water immediately and consult your doctor.
 - In the worst case, it will put out your eyes.
- For checking or handling of the battery, be sure to stop the engine and turn OFF the battery switch in advance.

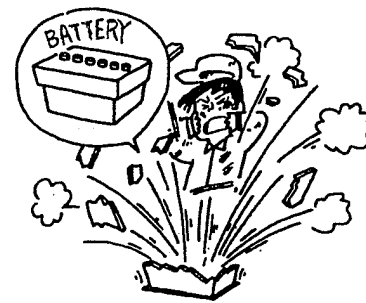
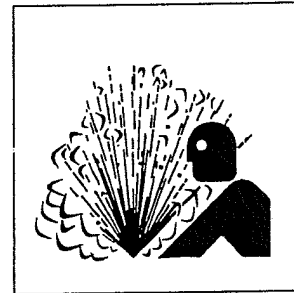

 **CAUTION**

Operator

- Do not operate the machine, if operator is tired too much or drinks some alcohol or take some drugs.
 - * Otherwise, it may cause unexpected accidents or injury.
- During checking or maintenance, be sure to put on suitable clothes and protectors.
 - * Do not put on baggy clothes, necklace, etc., because they are easily caught by projections which may cause injuries.

 **CAUTION**

Noise

- This machine generates large noise, if the door is open. Surrounding to large noise may cause hearing trouble.
 - * Close and lock the door during operation.
 - * If opening the door is necessary during operation, be sure to put on the ear protector.

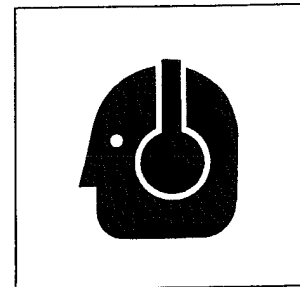

 **CAUTION**

Connection to house wiring

- Before connecting this machine to any building's electrical system, a licensed electrician must install an isolation(transfer) switch.
 - * Serious injury or death may result without this transfer switch.

CAUTION

Transportation

■ Do not lift the machine at the support hook or the ladder because it is not strong enough for lifting and may cause a falling accident.

* When lifting the machine, use the hanger located at the roof center.

* Keep out under the lifted machine.

■ Do not lift or do not transport the machine during operation, as it may cause damage to the fan or serious trouble.

* When loading the machine on the truck or the like, fix the machine firmly by support hooks on the both side.

「11-1. Specifications See p.68」.

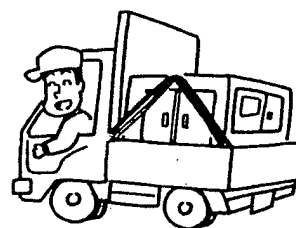
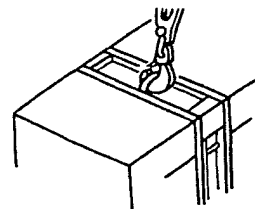

2. Construction

2-1 Outline and part names

Following is 45SPL.

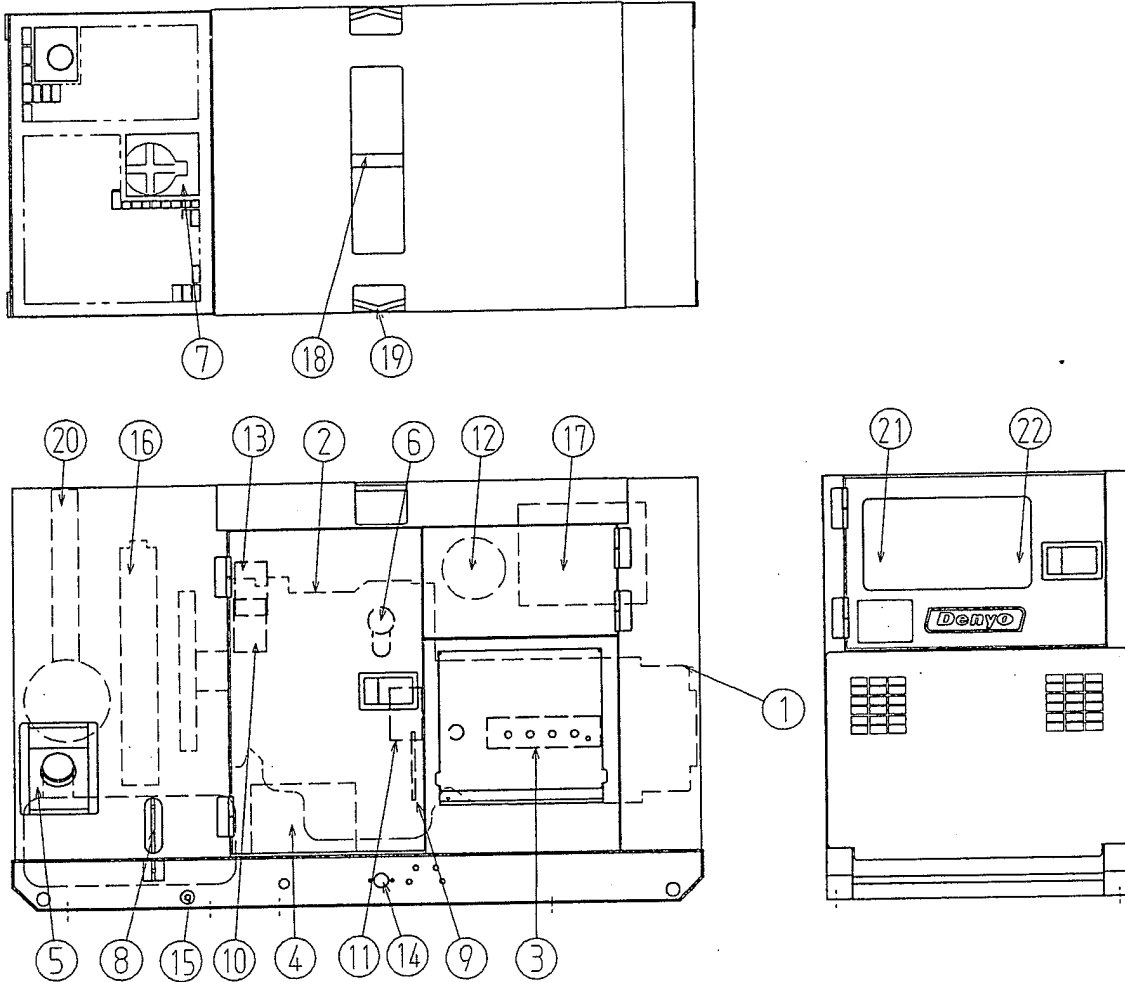

- | | | |
|--------------------|--------------------------------|-----------------------|
| 1 AC generator | 9 dipstick | 17 control box |
| 2 diesel engine | 10 fuel filter (opposite side) | 18 hanger rod |
| 3 output terminal | 11 oil filter (opposite side) | 19 support hook |
| 4 battery | 12 air cleaner | 20 exhaust gas outlet |
| 5 fuel in | 13 coolant reserve tank | 21 operating panel |
| 6 engine oil in | 14 oil drain plug | 22 control panel |
| 7 coolant in | 15 fuel drain plug | |
| 8 fuel level gauge | 16 radiator | |

2-2 Operating panel, control panel and part names

Following is 45SPI.

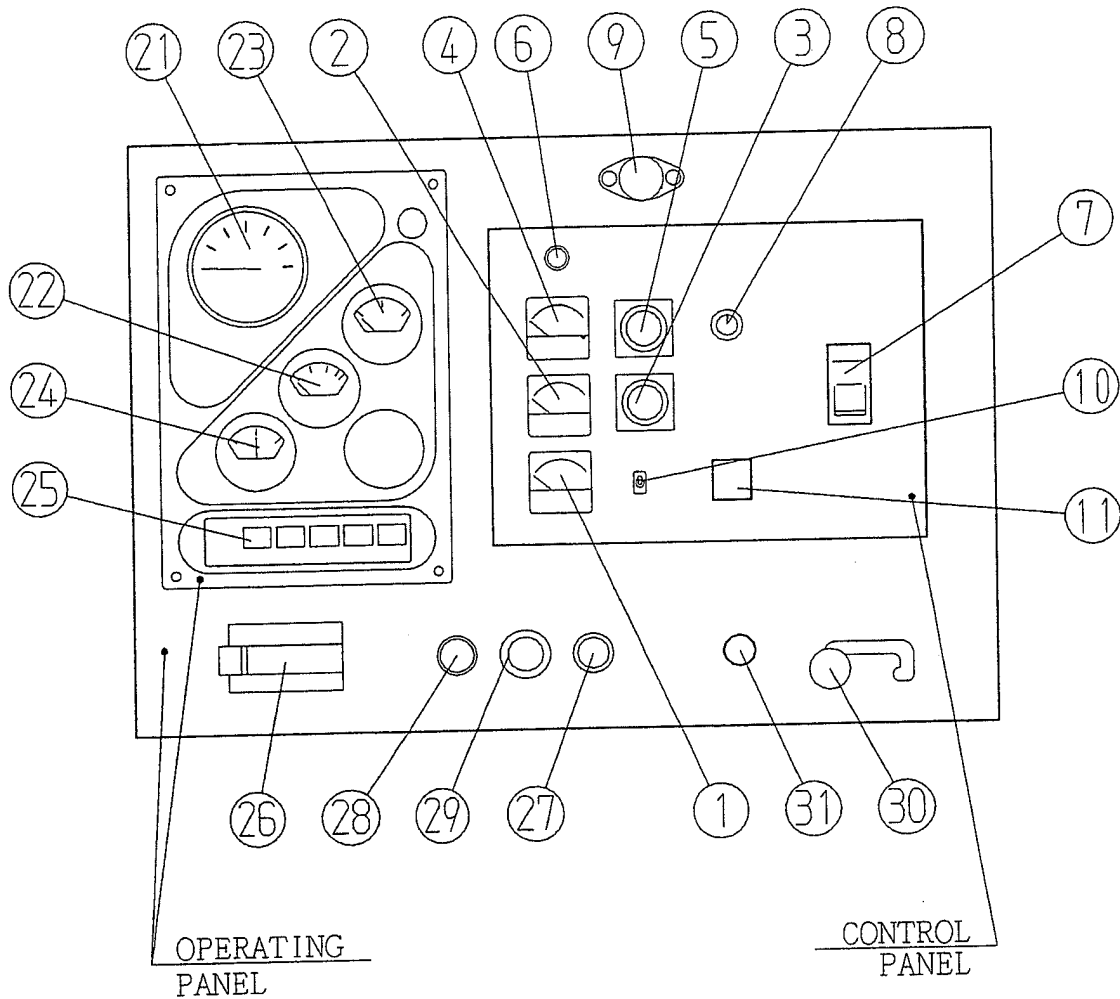

- | control panel | operating panel |
|--------------------------------|------------------------------|
| 1 frequency meter | 21 tachometer |
| 2 AC ammeter | 22 oil pressure gauge |
| 3 ammeter change over switch | 23 water tempreture gauge |
| 4 AC voltmeter | 24 charging ammeter |
| 5 voltmeter change over switch | 25 warning lamp unit |
| 6 pilot lamp | 26 battery switch |
| 7 circuit breaker (3-phase) | 27 starter switch |
| 8 voltage regulator | 28 preheat lamp |
| 9 panel light | 29 emmergency stop button |
| 10 panel light switch | 30 throttle lever |
| 11 earth leakage relay | 31 frequency adjusting screw |

2-3 Meters

Engine indicators

(1) Tachometer (0-3000rpm)

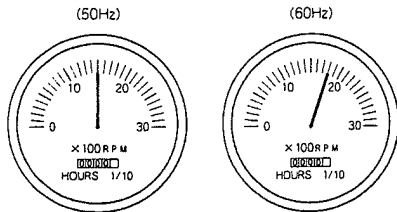

This meter indicates the number of revolutions (per minute) of the engine.

It indicates 1500rpm at 50Hz or 1800rpm at 60Hz.

(2) Hour meter

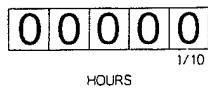

This meter indicates the total running time of the engine. This meter is built in the tachometer.

The hour meter has been set for use at 1500rpm. Accordingly, when the machine is used at 1800rpm, it indicates the total time approximately 20% more than the actual operation time.

(3) Water temperature gauge

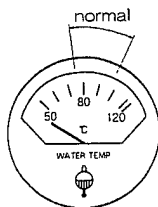

This is normal when it indicates 75 to 95 °C during operation.

[Note] If it indicates higher values, turn OFF the load and set the machine in cooling operation by setting the throttle lever to the "START/IDLING" position, and wait until the temperature lowers.

(4) Oil pressure gauge

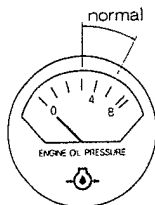

This is normal when it indicates 3 to 5×100kPa during operation.

If the engine is cool, it may indicate higher values at the time of startup. Put the engine in warming up operation and wait until oil pressure becomes normal.

(5) Charging ammeter

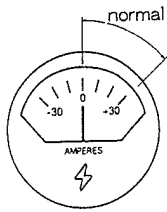

This meter indicates the current supplied by the alternator to batteries.

It is normal when it indicates the range of 0 or +.

Generator indicators

(1) Frequency meter

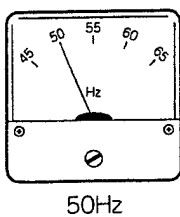

50Hz

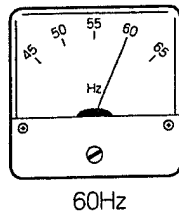

60Hz

This meter indicates frequency of the output voltage.

Make sure that it indicates 50Hz or 60Hz during operation.

(2) AC ammeter

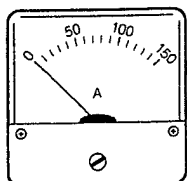

AC Ammeter

This meter indicates AC current flowing into the connected load. Make sure that it is always pointing below the rated current.

When running the three phase and single phase loads together, this meter indicates total current of them.

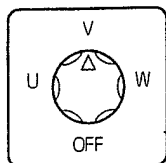

Ammeter change over switch

When running either the three phase or single phase load, this meter indicates the current flowing into the load.

The current of each phase can be checked using the ammeter change over switch. Ammeter change over switch is provided with the machine 45kVA or larger.

(3) AC voltmeter

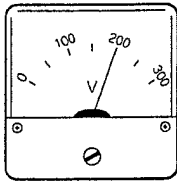

AC Voltmeter

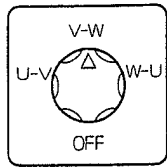

Voltmeter change over switch

This meter indicates AC output voltage. Make sure that it indicates rated voltage.

Line-to-line voltages can be checked using the voltmeter change over switch.

Indication/alarm lamp

(1) Preheat lamp

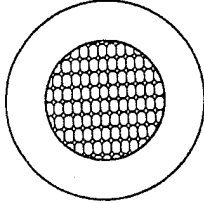

When the starter switch is set in the preheat position, this lamp becomes red heated in about 30 seconds, indicating that the machine has been preheated to be ready for startup.

(2) Warning Lamps

This monitor indicates the following failures, if any one of them occurs.

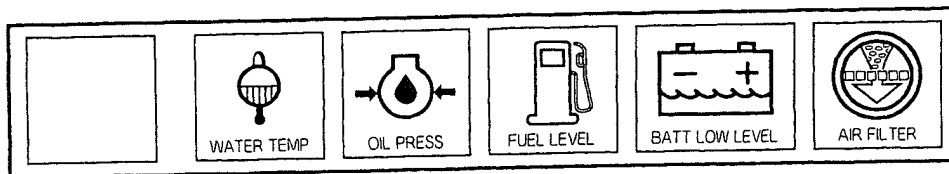

① High jacket water temperature (WATER TEMP)

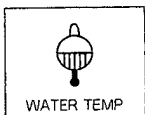

This lamp goes on when the water temperature rises abnormally. If the lamp goes on during operation, the emergency stop device immediately operates to shut down the engine automatically.

「5-1.(2) Check on engine cooling water See p.35」

② Oil pressure failure (OIL PRESS)

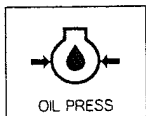

If the machine is in normal operation, this lamp stays off. When the starter switch is turned to "RUN" position to start the engine, the lamp goes on, and when the oil pressure rises after startup, it goes off. If this lamp goes on during operation, the emergency stop device immediately operates to shutdown the engine automatically.

「5-1.(1) Checking on engine oil See p.34」

③ Fuel level failure (FUEL LEVEL)

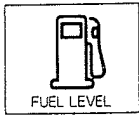

When fuel is running low, this lamp goes on, and it should be supplied at the tank.

「5-1.(4) Check on fuel See p.36」

④ Battery acid level failure (BATT LOW LEVEL)

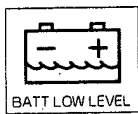

When battery acid is running low, this lamp goes on, and distilled water should be supplied to the battery.

「5-1.(5) Check on battery acid See p.37」

⑤ Air filter blinding (AIR FILTER)



When the air element is blinded, this lamp goes on. Indicating that the element should be immediately cleaned or replaced.

「8-3.(3) Cleaning of air cleaner element See p.56」

「8-5.(2) Replacement of air cleaner element See p.61」

2-4 Use of switches and controllers

Switches

(1) Battery switch

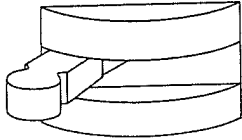

This switch should be set in the "ON" position during operation. And after stop the engine, this switch should be set in the "OFF" position.

[Note] Do not turn this switch to "OFF" position during operation. Otherwise, the engine may not be able to be stopped by normal operation, or it may cause damage to the electric equipment.

(2) Starter switch

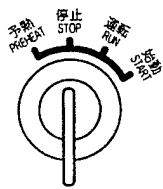

① Stop

This switch should be set in this position unless the machine is in operation. The key can be inserted or pulled out in this position.

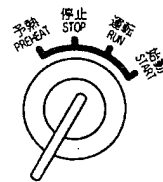

② Run

This switch should be set in this position when the machine is in operation.

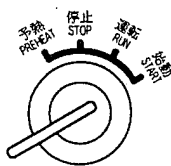

③ Start

This is the position to start the engine. When your hand is released from the key after starting, it is automatically set in the position of "RUN".



④ Preheat

This is the position to start the engine when the air temperature is low. Set the switch in this position until the preheat lamp becomes red heated, and then set it in the start position.

(3) Speed control device

- Throttle lever

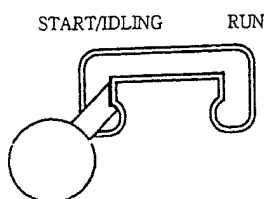

This lever is used to control the engine speed. Set the lever at the "START/IDLING" position for startup or warm up/cooling operation of the engine and at the "RUN" position for constant speed operation of the machine (at 50Hz or 60Hz).

- Frequency adjusting screw

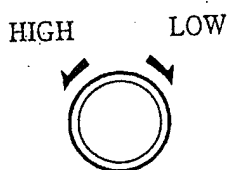

This screw is used to adjust the frequency. With the throttle lever set at the "RUN" position, turn the screw to the "HIGH" side to increase the frequency and to the "LOW" side to decrease it.

(4) Circuit breaker

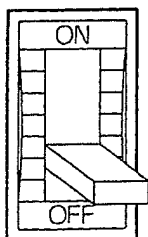

This is a main switch to supply power to a load. When the load is shorted or in the state of overload, it trips to protect the generator against trouble.

[Note]

Do not use this circuit breaker to turn ON/OFF the load, to prevent damage to the circuit breaker.

When it trips with over current, the handle of the breaker stops between ON and OFF positions. This is what is called the trip condition.

In this case, push the handle down to the OFF position to reset it, or else, it cannot be set in ON position.

Voltage regulator and overcurrent relay

(1) Voltage regulator

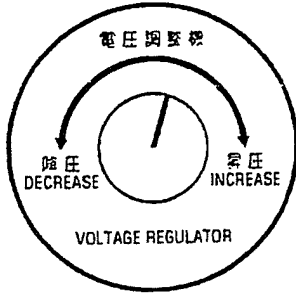

This regulator is used to control the output voltage. Turn the regulator to clockwise to increase the voltage and counter clockwise to decrease it.

Adjust the voltage to the rated voltage with this regulator.

(2) Overcurrent relay

RESET BUTTON

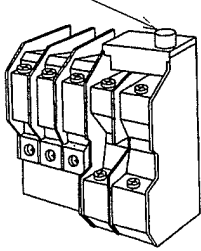

This relay is used to trip the circuit breaker (for 3 phase) when over current flows into the circuit.

If the circuit breaker (for 3-phase) trips and cannot be closed, stop the engine and open the control panel. Then, press the reset button.

[Note]

Do not change the set value unnecessarily.

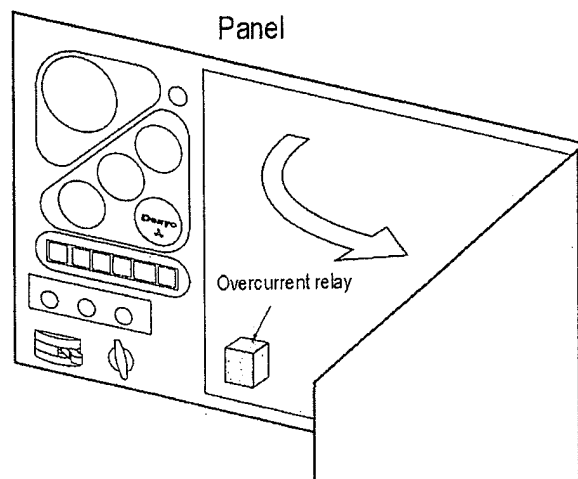

3. Transportation and installation

3-1 Transportation of machine



CAUTION

Transportation

- Do not lift the machine at the support hook or the ladder because it is not strong enough for lifting and may cause a falling accident.

- * When lifting the machine, use the hanger located at the roof center.
- * Keep out under the lifted machine.

- Do not lift or do not transport the machine during operation, as it may cause damage to the fan or serious trouble.

- * When loading the machine on the truck or the like, fix the machine firmly by support hooks on the both side.

The detail as machine size is referred to 「11-1. Specifications See p. 68」

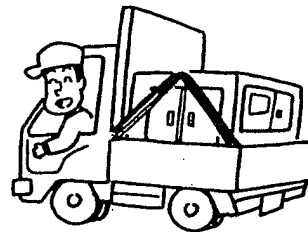
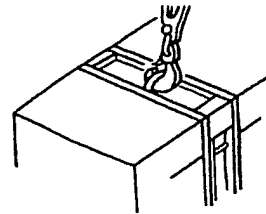

3-2 Installation of machine

WARNING

ENGINE EXHAUST can kill.

■ Insufficient ventilation may lead to death due to lack of oxygen or poisoning by exhaust gases.

- * Do not use the machine in a place of poor ventilation or in a place where exhaust gases stays.
- * Do not use the machine indoors or in storehouse, tunnel, ship hold, tank, etc. of poor ventilation.
- * If it becomes necessary to use the machine in the above places, the exhaust pipe should be extended to a well ventilated place. In this case, use a ventilator to ensure proper ventilation.
- * Do not direct the exhaust outlet to nearby pedestrians and houses.

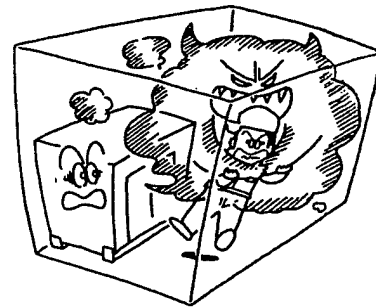
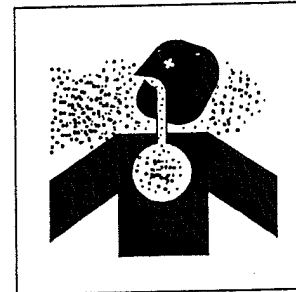

[Note] vibration:

The engine, running, generates vibration during operation of the machine.

When installing the machine, be sure to observe the following points.

- ① Install the machine horizontally on a solid foundation.
Operation on an uneven place will generate unusual vibration.
- ② The machine should be installed on a substantial base to prevent claims from nearby living people. For details of the vibration level of the machine and foundation work, contact distributor or our office.

[Note] noise:

The engine is running during operation of the machine.

If the door is open, much noise will be generated. But some noise will stay, when door is closed.

When installing the machine, be sure to observe the following points.

- * Close and lock the door after installation.
- * We recommend to execute the measure for sound level to prevent claims from nearby living people.

Installation procedure

- * Install the machine horizontally on a solid foundation.
- * Provide a space of more than about 1m at the side of the control panel and fuel feed port to ensure correct operation and supply.
- * Provide a space of more than about 1.2m on the left and right sides for check of the engine, oil supply and cable connection work.
- * A sufficient space is required at the top of the machine to allow hot air (exhaust air) from the radiator and exhaust gases to be discharged and to supply water to the radiator.
- * When the machine is operated in a place with much dust or salt, careful maintenance is required to prevent clogging or damage to the radiator or poor insulation of electric parts.

Indoor installation

- * Exhaust gases should be discharged outdoors using an exhaust pipe.
- * Exhaust air should also be discharged outdoors using a duct or the like.
- * Insufficient indoor ventilation will raise the (indoor) temperature and affects the performance of the machine.
- * For details of required volume of ventilation, contact distributor or our office.

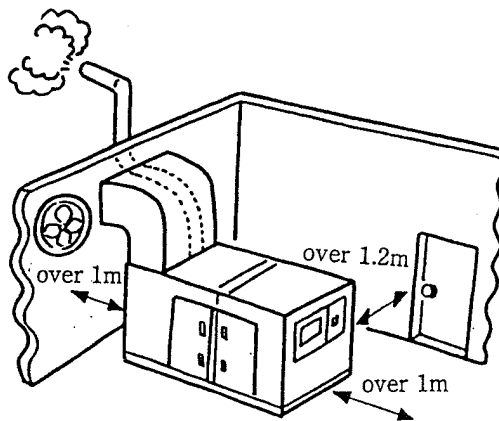

4. Connecting the load

4-1 DOUBLE VOLTAGE

WARNING

ELECTRIC SHOCK can kill.

- Do not touch the circuit inside the machine during operation to prevent decrease due to electric shock.

* When open the control panel or the like for changing the output voltage, turn OFF the breaker and stop the machine in advance.

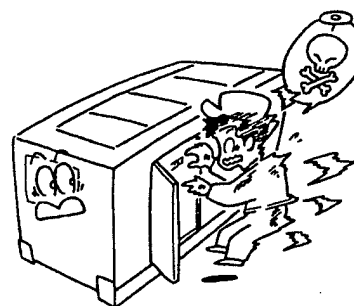

(1) Description

The machine is designed with double voltage specification, which allows the output voltage of 200 V class or 400 V class to be selected with the voltage change over cables.

(2) Method for selecting output voltage

The machine is shipped from the plant with its output voltage normally set at 200/220V unless otherwise specified.

Therefore, select the output the voltage required for work in accordance with the procedure described following :

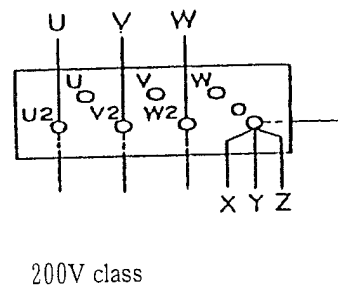
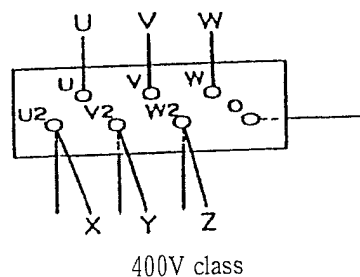

- ① The voltage change over panel is located on the right door of the rear side, and remove the protecting cover first.
- ② Select the desired output voltage by connecting the change over cables as shown in the figure in the previous page.
- ③ As the final step, close the control panel on the control box, close the control panel or mount the protecting cover and close the right door of the rear side.

[Note] Improper connection of the change over cables, it may result in burning of the generator.

In changing the output voltage, tighten the locking nuts securely. Note that insecure tightening of the nuts may result in burning.

Close the control panel or mount the protecting cover to prevent the hazard during operation.

4-2 Cables to be used

Selection of cables:

Use cables having sufficient size in consideration of the allowable current of the cables and the distance between the machine and the load.

If the load current exceeds the allowable current of cables, the cable may be damaged by overheat. Also, if the cables are too small in size for the length, the input voltage of the load drops which lowers the working efficiency or causes failure in operation.

Select the length and size of cable so that the voltage drop "e" obtained by the following equation is within 5% of the rated voltage.

* Equation to obtain 3-phase, 3-wire system voltage drop "e" from the length and size of cable and operating current is as follows.

$$e = \frac{1}{58} \times \frac{L}{S} \times I \times \sqrt{3}$$

where e: voltage drop (V) L: length (m)
S: cable thickness(mm²) I: load current (A)

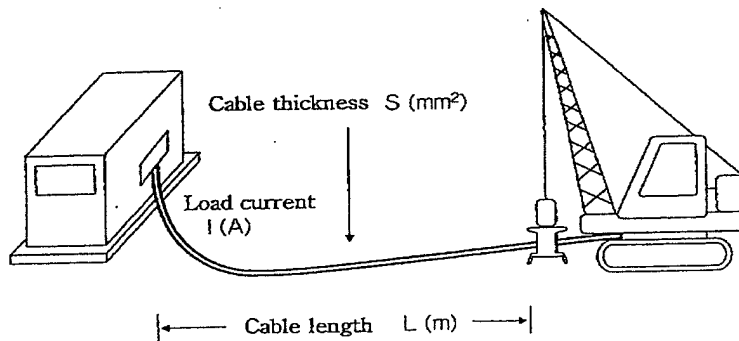

4-3 Connecting the load

ELECTRIC SHOCK can kill.

- Do not touch the output terminals during operation to prevent decrease due to electric shock.
- * When a wiring work is required, be sure to turn OFF the circuit breaker and stop the machine.
- * When operating the engine, close the output terminal cover. Tighten the fixing bolts before operating the machine.



- Do not use damaged cables to prevent electric shock. Insufficient tightening of bolts will generate heat at connections which may result in fire accidents.
- * When connecting, make sure the connecting cables are normal and connected firmly to the output terminals.

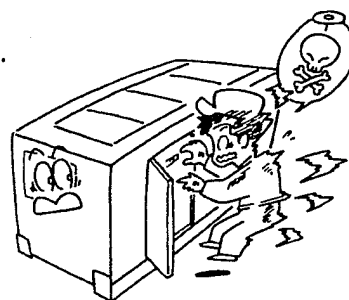

CAUTION

Connection to house wiring

- Before connecting this machine to any building's electrical system, a licensed electrician must install an isolation(transfer) switch.
- * Serious injury or death may result without this transfer switch.

(1) Fastening the output terminal

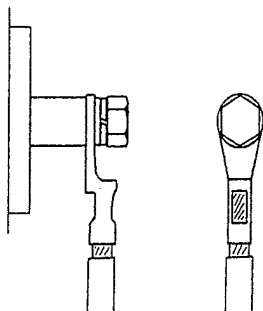

[Note] In connecting the load, tighten locking bolts securely with a spanner or the like to prevent burning.

(2) Connecting three phase output terminal

Connect the load to the output terminal after confirmation of load phase and voltage.

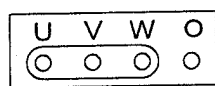

Use U/V/W for three phase load

200/220V or 400/440V

(190V) (380V)

{415V}

[240V] [480V]

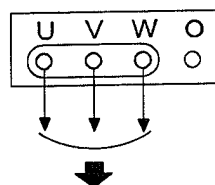

Use O/U,O/V,O/W for single phase load

115/127V or 231/254V

(110V) (219V)

{240V}

[139V] [277V]

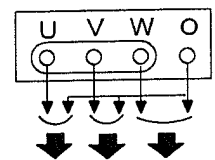

Use U/V,V/W,W/U for single phase load

200/220V or 400/440V

(190V) (380V)

{415V}

[240V] [480V]

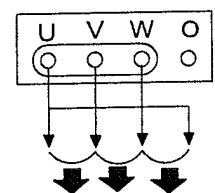

(3) Precaution in load connection

- ① Be sure to provide a switch for turning the load ON and OFF between the output terminal block and the load.

Note that the use of the breaker of the machine for turning the load ON and OFF may result in breaker failure.

- ② In connecting the load, be sure to stop the engine and turn OFF the breakers on the control panel and the out put terminal block.
- ③ Don't contact the connecting cable to the output terminal of other phase on the output terminal block.
- ④ When the load connection is finished, close the cover of output terminal and tighten by the bolts.

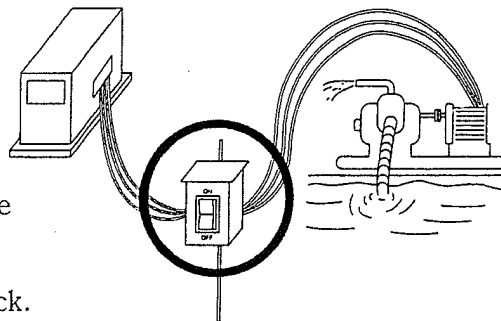

4-4 EARTH LEAKAGE RELAY and Grounding

WARNING

ELECTRIC SHOCK by leak can kill.

- Improper grounding may lead to death due to electric shock. Because the device for leakage protection does not operate effectively.

* Grounding terminal for the earth leakage relay, case grounding terminal and case of the load are grounded.



(1) Description of the device

The machine is provided with an earth leakage relay to detect any leakage produced due to such trouble as insulation failure of the load during operation and to cut off the circuit for protection against any accident such as electrocution resulting from the trouble.

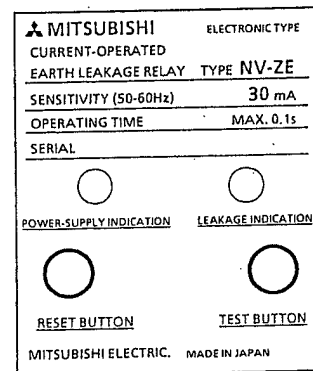

The current sensitivity of this relay is 30 mA.

Improper handling of the relay may lead to unsafe condition in comparison with that does not use the relay.

To ensure further safety, install a leakage relay for each load at the position near the load.

(2) Grounding

Ground as following to operate the earth leakage relay certainly.

■ Grounding of the machine

Ground the grounding terminal for earth leakage relay and case grounding terminal according to the below.

① Grounding of the grounding terminal for earth leakage relay

If grounding described below does not comply with the local rule, stricter of the two shall apply.

Use the grounding wire which sectional area is 5.5mm^2 or larger.

Usually it is possible that using attached grounding rod. But if grounding resistance is over $100\ \Omega$, provide the grounding rod which surface area contacted the ground is large.

② Grounding of the case grounding of the machine

Use the grounding wire which sectional area conforms to the local rule.

Provide the grounding rod to satisfy the grounding resistance which conforms to the local rule.

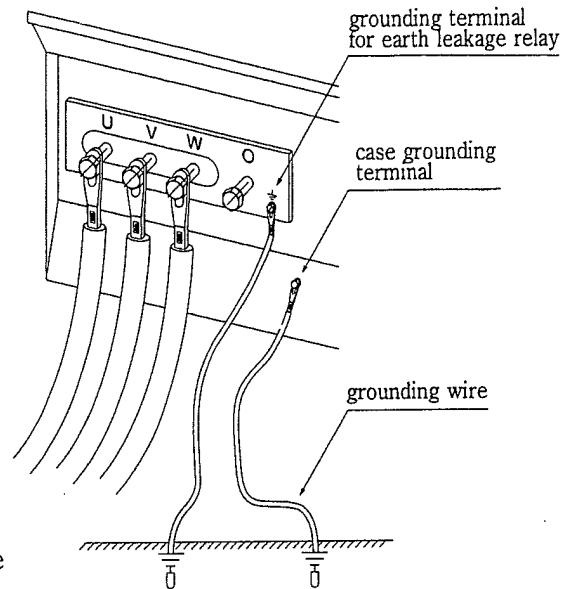

■ Grounding of the load equipment

As in the case of the machine, execute grounding work on the load equipment case. Provide the grounding rod to satisfy the grounding resistance which conforms to the local rule.

[Note] The installation of a leakage relay on the machine can not become a reason for elimination of the need for the load side grounding.

The load side grounding is indispensable for earliest possible detection of any leakage caused in the generator. The absence of such grounding requires any leakage to be detected by current flowing through the human body and is very dangerous because the sensitivity of leakage relay provided on the machine is not sufficient for detection of such current.

■ Precaution in grounding

- ① Select a shady and highly moist place, and bury the grounding rod in such way that its top end is completely hidden in the ground.
- ② If burying the grounding rod on the place that many pedestrians walk on, clamp the lead wire to prevent catching on it.
- ③ If the lead wire is not long enough for the connection, connect it as directed below:
 - (1) Connect the lead wire and the extension wire by soldering or sleeve coupling securely and apply insulating tape to the connection.
 - (2) Do not bury the connection in the ground.
- ④ Avoid the places within 2m of lightning conductor grounding location for burying of grounding rod.
- ⑤ Do not use a telephone set grounding conductor.

■ Operation check

For safety reasons, check on the operation of the leakage relay at the startup of the machine according to the procedure described below:

- ① Start up the machine according to
「5-2 Startup See p. 39」
- ② Make sure that all breakers of the load side are "OFF".
- ③ Set the breaker of three phase to "ON".
- ④ Press the TEST button on the leakage relay.
If this causes the LEAK lamp (red) on the leakage relay to go on and the breakers to be activated, the leakage relay can be regarded as operating normally.
- ⑤ Press the RESET button and return the breaker to the "OFF" position. This allows the breaker to be turned to "ON" again.

The leakage relay, once it is activated, holds its activated state until the RESET button is pressed or the machine is stopped.

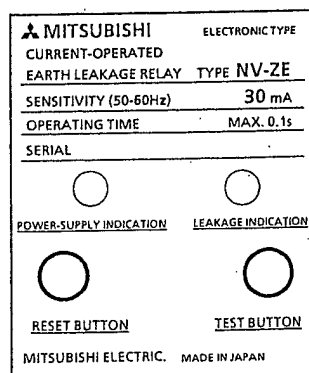

(3) Action for operation of the leakage relay

When the leakage relay is activated, then stop the engine, and measure the insulation resistance several parts and repair the leak spot before restart the engine.

5. Operation

– From pre-start check to shut down –

Be sure to check the machine prior to starting.

1. Pre-start check : Check oil, cooling water, fuel and so on.
2. Periodical check: Check each part of the machine according to operating time.
3. Startup: Check the surroundings of the machine for safe operation.

Use a sign before startup.

4. Operation:  In the machine there are moving parts, high temperature parts and high voltage parts. Before operating, close the door and lock the side door for safe operation and for prevention of noise.

[Note] If the warning lamp lights, stop the engine and check the cause of it.

[Note] Check for leaks of oil, water, exhaust gases, and for unusual noise.

5. Shut down

5-1 Checking prior to operation

WARNING

MOVING PARTS can cause severe injury.

- Rotary unit which runs at a high speed is located in the machine.

(Note that it is very dangerous if you touch it.)

- * Be sure to close the door and lock it during operation.
- * When making check or maintenance of the machine, be sure to stop the machine in advance.

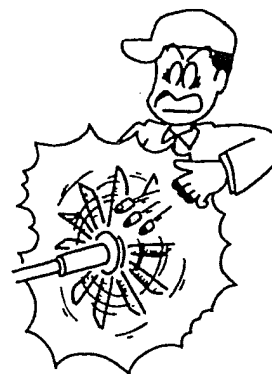
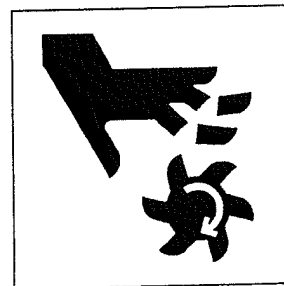

- To prevent unexpected trouble, be sure to check the following points.

- (1) Check on engine oil (lubricating oil)
- (2) Check on engine cooling water
- (3) Checking on fan belt
- (4) Checking on fuel
- (5) Checking on battery acid
- (6) Checking on grounding for electric shock protection
- (7) Checking for leakage of oil and water
- (8) Checking for loose parts
- (9) Removal of foreign objects in machine

Inspection:

- (1) Checking on engine oil

(Read the instruction manual for the engine furnished separately.)

- ① Checking the level of engine oil by the dipstick. Make sure the oil level is always between H and L.
- ② When it is below the low limit, supply oil immediately.
- ③ At the same time, check condition of oil by the dipstick.

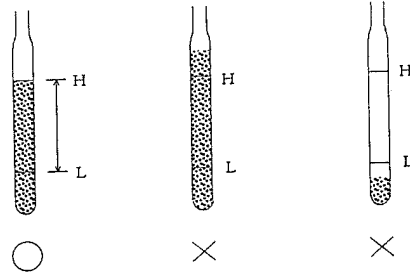
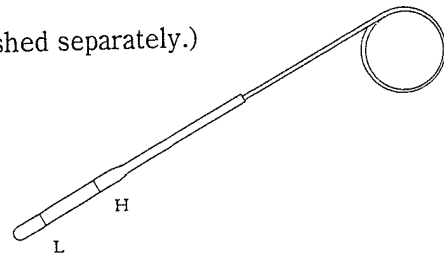

[Note]

Oil is consumed gradually during operation. When the machine is to be used continuously for a long time, be careful with lack of oil.

- (2) Check on engine cooling water
(Read the instruction manual for the engine furnished separately.)

WARNING

HOT COOLANT can cause severe scalds.

- If the radiator cap is opened while the water temperature is high, steam or hot water will spout out.

* During operation or immediately after stopping the machine, do not open the radiator cap while the water temperature is high.

* When cooling water needs to be checked or supplied, wait until the engine is cooled (50 °C or less as measured with the water temperature gauge).

- ① Check (to see) that cooling water in the reserve tank is within the range of FULL–LOW.
- ② When it is below the low limit, supply (additional) water immediately.
- ③ Normally, only the water level of the reserve tank needs to be checked.

But, the radiator cap should be opened once a week to check that water is full in the radiator.

[Note]

When closing the radiator cap after water level is checked or water is supplied, turn the cap fully clockwise so that it can be firmly tightened.

Otherwise, cooling water is evaporated which results in serious damage to the engine.

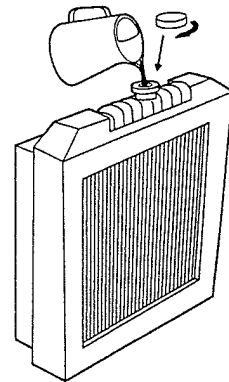
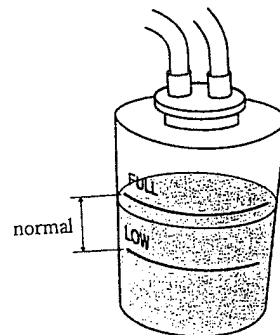
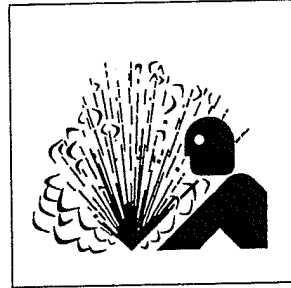

(3) Check on fan belt

(Read the instruction manual for the engine furnished separately.)

- ① Check the belt for tension and elongation.
Also, check it for damage. Replace if necessary.
- ② For adjustment or replacement of the belt,
refer to the instruction manual for the engine.

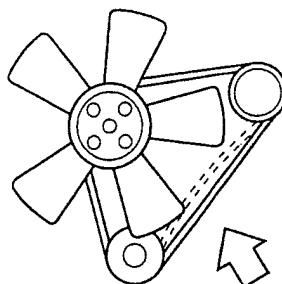

Press (about 6kg) the position shown by arrow mark (middle of belt) with your thumb. The bend should be within the range of 10–15mm.

(4) Check on fuel

- ① Be sure to check the quantity of fuel prior to operation to prevent lack of fuel during operation.
- ② Loosen the drain plug of the fuel tank from time to time, and remove sediments and water at the bottom of the tank.

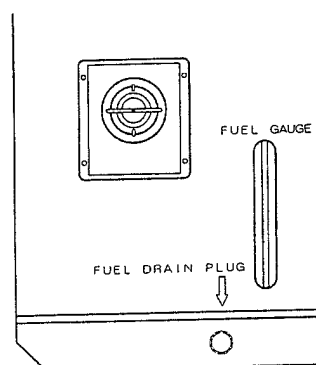

(5) Check on battery acid

 **CAUTION**

BATTERY

■ The battery acid is dilute sulfuric acid. Improper handling will cause unexpected burns.

* When the battery acid gets on your clothes or skin, wash it out with a large volume of water immediately. If it gets in your eyes, wash with a large volume of water immediately and consult your doctor.

– In the worst case, it will put out your eyes.

Remove the battery acid plug(cap) and check the liquid level (10–12mm above the electrodes). Supply distilled water if necessary.

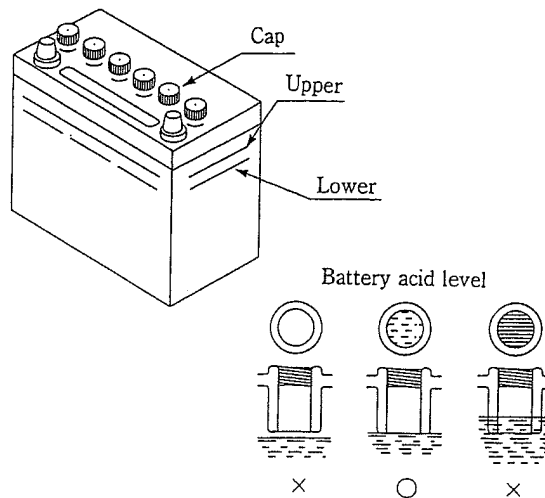

(6) Check grounding for electric shock protection

Make sure that the case grounding of the machine and the load are certainly.

「4-4.(3)Grounding See p.31」

Do not ground directly 「O」 terminal.

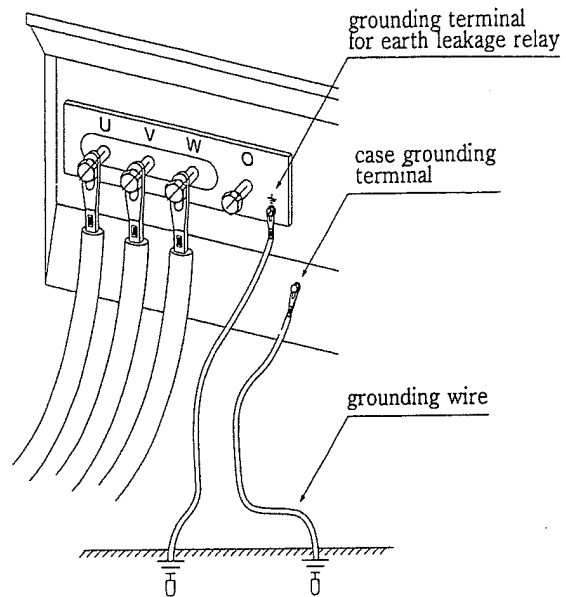

(7) Check for leak of water and oil

Check the machine for the trace of leak of oil or water. If a leak is found, check the location of leak and stop it. When the leak cannot be stopped, contact our service factory.

(8) Check for loose parts

Check for loose bolts and nuts. Loose parts should be tightened firmly. Particularly, make check on (the fitting of air cleaner, muffler, turbo-charger, etc.), disconnection of electric wiring, short-circuit and loose terminals.

(9) Removal of foreign objects in machine

- * Check that tools and cleaning cloth are not left in the machine. Remove if necessary.
- * Check the surroundings of the muffler and engine for presence of dust and flammable objects. Remove if necessary.
- * Check that the cooling air inlet and the cooling air outlet of the machine are not clogged with dust or other objects. Remove if necessary.

5-2 Startup

Following is flow of startup.

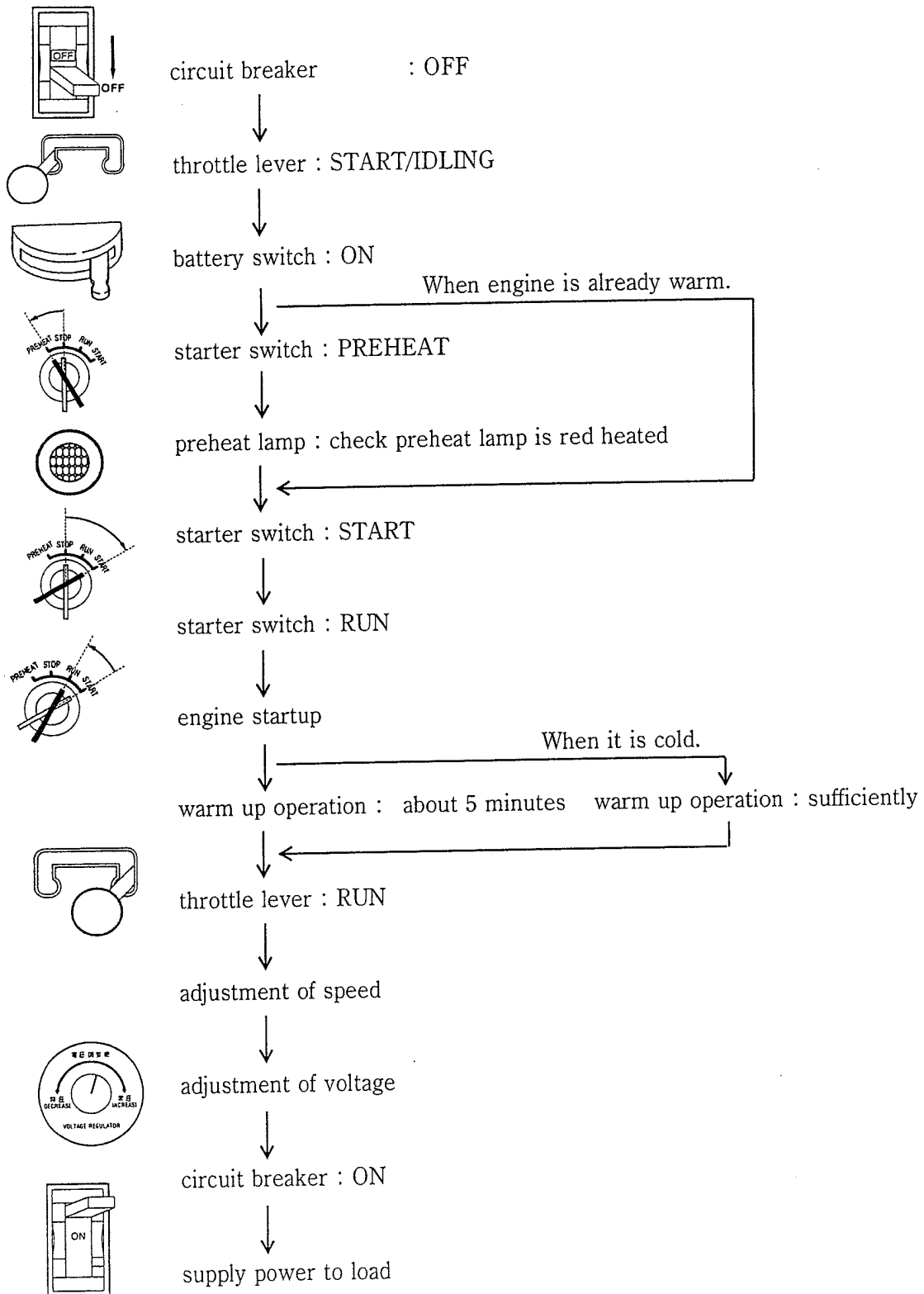

CAUTION

* Do not start the engine when the machine and the load circuit breaker are ON, or else, power is supplied to the load at the start of the engine which causes electric shocks or trouble in the load.

Startup procedure:

- (1) Make sure that the circuit breakers of the machine and the loads are all OFF.
- (2) Turn the battery switch to ON and set the throttle lever in the "START / IDLING" position.

- (3) Set the starter switch in "Preheat" position. This switch must be ON until the preheat lamp becomes red heated. Turn the starter switch to "START" position until engine starts.

[Note]

If the engine is warm, the preheat operation is not required.

- (4) If engine starts up, set free the starter switch. Make sure that 「 Oil Pressure Failure 」 in the warning lamp unit goes off.

- (5) Drive the machine for warming up the engine for about 5 minutes at the "START / IDLING" position of the throttle lever.

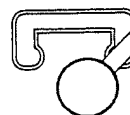
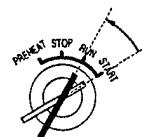
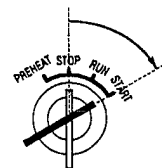
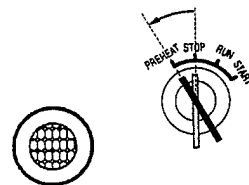
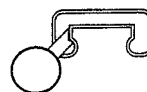
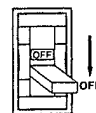

(6) After warming up the engine, set the throttle lever to the "RUN" position. And check on the idling speed is as specified in the following table by the frequency meter. If the idling speed is required, adjust the idling speed by the frequency adjusting screw.

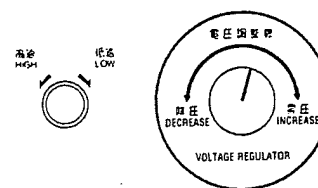

Commercial frequency	Frequency (Idling speed)
Operation at 50Hz	52.5Hz (1575rpm)
Operation at 60Hz	62.5Hz (1875rpm)

If the idling speed set above speed, frequency becomes nearly 50Hz or 60Hz in the rated load.

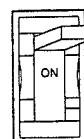

(7) Set the voltage to the rated by the voltage regulator, and turn the breaker to "ON". The machine starts power transmission state.

5-3 Handling during operation

(1) Checking after startup

- ① Make sure that each meter and lamp are normal.

normal : warning lamp is all off
(See P.16)

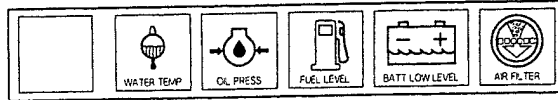

- ② Make sure that the color of exhaust gases from the engine is normal.
Check for unusual noise and vibration.

Color of exhaust gases

- Colorless or light blue: Normal
 - Black: Abnormal, incomplete combustion
 - White: Abnormal, combustion of oil due to failure of oil

- ③ Check on the operation of the earth leakage relay.
(See P.32)

(2) Adjustment during operation

Set the tachometer and frequency meter to the rated by the throttle handle.
Set the voltmeter to the rated by the voltage regulator.

[Note]

* Do not set the throttle lever in "START/IDLING" position or do not decrease the speed by the frequency adjusting screw during operation of the load, or else, the generator voltage and frequency will go down, resulting in failure in operation of the load device or any other trouble.

Do not turn the battery switch to "OFF" position or do not remove the battery, or else, engine will not stop normally or resulting in trouble of electrical equipment.

5-4 Shut down

- (1) Turn OFF the circuit breaker of the load.
- (2) Turn OFF the circuit breaker of the machine.
- (3) Set the throttle lever in "START / IDLING" position and put the machine in cooling operation for about 5 minutes.

circuit breaker of the load

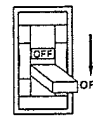

circuit breaker of the machine

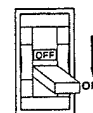

cooling operation for about 5 min.

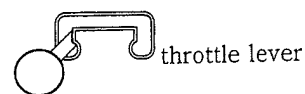

- (4) Set the starter switch in "STOP" position.
The engine will stop immediately.

starter switch

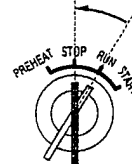

- (5) Turn the battery switch to "OFF" .

[Note]

Do not leave the machine keeping the battery switch at "ON", the battery is discharged.

battery switch

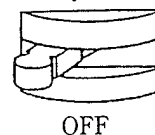

- (6) Remove the key from the starter switch and keep it at hand.
- (7) Check the amount of fuel. Supply additional fuel if necessary.
- (8) Check for leakage of oil, fuel and water.

[Note]

For emergency stop, keep pushing the "EMERGENCY STOP" button until the engine stops.

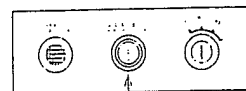

emergency stop button

5-5 Protection device

Protection devices and emergency stop devices are provided for protection of the machine against trouble during operation. When the running caution lamp lights, stop the engine immediately. Check and remove the cause of trouble.

Table of protection device

warning \ action	turn OFF the circuit breaker	stop the engine	indicate by warning lamp	function
high jacket water temperature (WATER TEMP)	—	○	○	When the cooling water temperature rises abnormally, the device acts. Set point : 105 °C
oil pressure failure (OIL PRESS)	—	○	○	When the oil pressure falls abnormally, the device acts. Set point : 98 kPa
fuel level failure (FUEL LEVEL)	—	—	○	When fuel supply is necessary because of fuel shortage, the device acts.
battery acid level failure (BATT LOW LEVEL)	—	—	○	When the battery acid is failure, the device acts.
air filter blinding (AIR FILTER)	—	—	○	When replace or cleaning of air filter is necessary because of blinding of filter, the device acts
overcurrent	○	—	—	When overcurrent flows, the device acts
earth leakage	○	—	○	When electric leakage, the device acts Current sensitivity : 30mA

6. Lubrication, cooling water and fuel

6-1 Engine oil

Use specified engine oil, otherwise, it greatly affects the startup operation and life of the engine.

(1) Kind of oil

Use oil, CD class or higher, classified by API service.

(2) Oil viscosity

Recommended oil viscosity is SAE 10W-30, all-season type.

Use oil according to ambient temperature referring to the table below.

Ambient temperature (°C)						
-30	-20	-10	0	10	20	30
		← SAE 20 →				
			← SAE 30 →			
←	SAE 5W-20			→		
←		SAE 10W-30				→
←	SAE 15W-40					→

[Note]: Do not mix with different kind of oil, or else, it deteriorates the oil quality.

(3) Quantity of replacement oil

Total oil quantity	DCA-45SPI	14.0 L (0.7)
	DCA-60SPI	19.3 L (1.0)
	DCA-75SPI	19.3 L (1.0)
(Value in parentheses is filter capacity.)		

6-2 Cooling water

(1) Water for cooling

Use the mixture of the good quality soft water like city water and the Long Life Coolant (LLC) of anti-freeze and anti-rust for the aluminum radiator.

Percentage of LLC must be 30% to 50%, Under the 30%, the anti-rust effect will decrease, and over the 50%, the anti-freeze effect will decrease.

The following percentages are recommended for each ambient temperature;

30%: -10 °C

40%: -20 °C

50%: -30 °C

In case of replenishment, use LLC of the same brand and the same density. Normally LLC should be replaced every 2 year.

(2) Total quantity of cooling water

Total cooling water quantity	DCA-45SPI	1 3. 9 L (1. 0)
	DCA-60SPI	1 9. 0 L (1. 0)
	DCA-75SPI	2 2. 9 L (2. 4)

(Value in parentheses is reserve tank capacity.)

6-3 Fuel

(1) Fuel to be used

#2 Diesel Fuel

[Note]

If other kinds of fuel is used or fuel being used contains water or dust, it deteriorates the engine performance or leads to a serious trouble.

7. Handling of battery

CAUTION

BATTERY

- Battery generates flammable gases.
Improper handling may lead to explosion or serious injury.
 - * Battery should be charged in a well ventilated location. Otherwise, flammable gases are accumulated which may be ignited and exploded.
 - * When connecting a booster cable, do not jumper the terminals (+ and -). Otherwise, the flammable gases generated from the battery may be ignited and exploded by sparks.
 - * For maintenance of the machine, disconnect the cable on the ground side.
- The battery acid is dilute sulfuric acid. Improper handling will cause unexpected burns.
 - * When the battery acid gets on your clothes or skin, wash it out with a large volume of water immediately. If it gets in your eyes, wash with a large volume of water immediately and consult your doctor.
 - In the worst case, it will put out your eyes.
- For checking or handling of the battery, be sure to stop the engine and turn OFF the battery switch in advance.

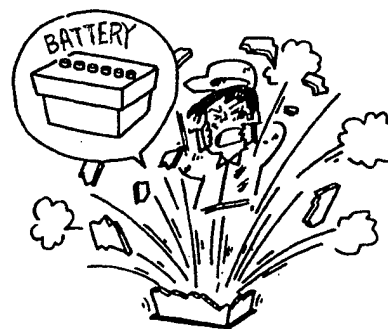
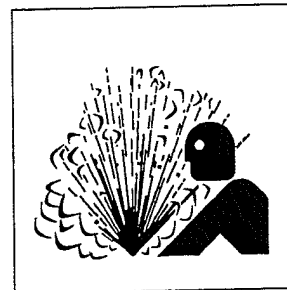

7-1 Caution on battery charge

Charging of loaded battery

- * Disconnect the wiring cable from the battery terminals before charging. (Otherwise, the alternator may be damaged due to unusual voltage applied to the alternator)
- * When disconnecting the wiring cables from the battery terminals, remove the ground cable first. (If a tool touches the space between the "+" terminal and the machine, electric spark will occur which is very dangerous)
When connecting the wiring cables to the battery terminals, connect the ground cable last.
- * While the battery is being charged, open all the liquid plugs to discharge the gas.
Keep the battery away from fire to prevent unexpected explosion.
Handle the battery carefully to prevent electric sparks.
- * If the battery is overheated (liquid temperature above 45 °C), stop charging for a while.
- * At the completion of charging, stop charging immediately.
(The relation between battery charge condition and specific gravity See p.58)

If the battery is still charged, the following trouble will occur.

- 1) Battery overheat
 - 2) Decrease in battery acid
 - 3) Deterioration of battery performance
- * Do not connect the battery polarity in reverse (connection of "+" and "-" or "-" and "+") to prevent damage to the alternator or the like.

7-2 Connection of booster cable, and installation

When the engine is started using booster cables, connect the cables as follows.

(1) Connection of booster cable

- ① Connect the clip of the booster cable "A" to the terminal "+" of the machine in trouble.
- ② Connect the other clip of the booster cable "A" to the terminal "+" of normal machine.
- ③ Connect the clip of the booster cable "B" to the terminal "-" of normal machine.
- ④ Connect the other clip of the booster cable "B" to the engine block of the machine in trouble.

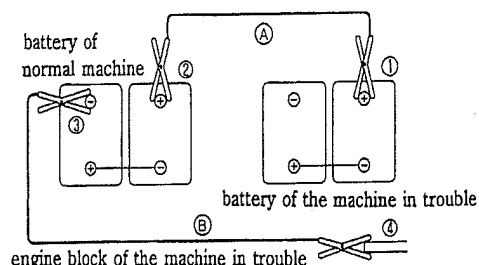

(2) Removal of booster cable

- ① Remove the clip of the booster cable "B" connected to the engine block of the machine in trouble.
- ② Remove the clip of the booster cable "B" connected to the terminal "-" of normal machine.
- ③ Remove the clip of the booster cable "A" connected to the terminal "+" of normal machine.
- ④ Remove the clip of the booster cable "A" connected to the terminal "+" of the machine in trouble.

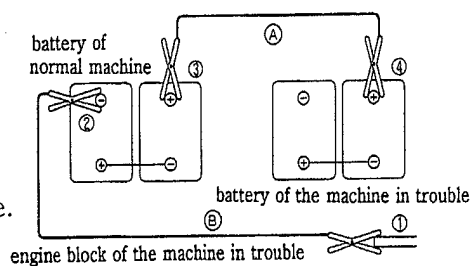

(3) Caution on handling of booster cable

- ① Use booster cables and clips of the size that matches the size of battery.
- ② The battery used for normal machine should be the same in capacity as the battery of the machine in trouble.
- ③ After connection, check that clips are firmly connected.
- ④ When connecting booster cables, make sure that the terminal "+" does not touch the terminal "-".
- ⑤ The engine block should be connected at a place more than 30cm away from the battery.

8. Periodical checking and maintenance

(Read the instruction manual for the engine furnished separately)

WARNING MOVING PARTS can cause severe injury.

- Rotary unit which moving parts at a high speed is located in the machine.

Care should be taken during operation.

- * When the machine needs checking or maintenance, be sure to stop it in advance.

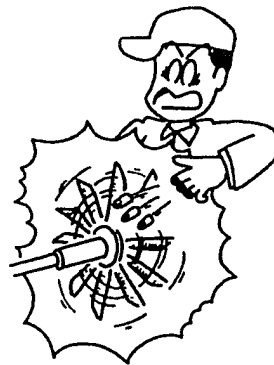
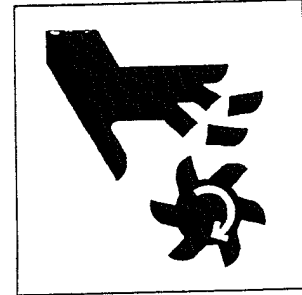

WARNING ELECTRIC SHOCK can kill.

- High voltage units are located in the machine.

Care should be taken during operation.

- * When the machine needs checking or maintenance, be sure to stop it in advance.

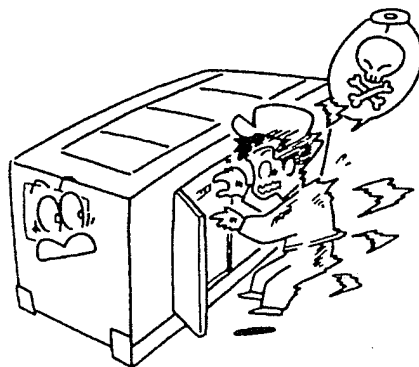
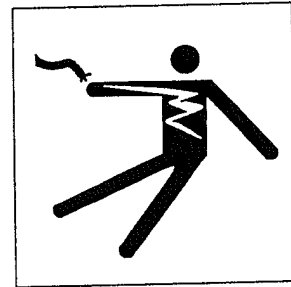

⚠ CAUTION HOT PARTS can burn skin.

- High temperature parts are located in the machine.
Care should be taken during operation.
- * When the machine needs inspection or maintenance,
be sure to stop it in advance.
- * Even after the machine stops, the inside of the
bonnet is still hot.
Wait until the engine is cooled sufficiently.

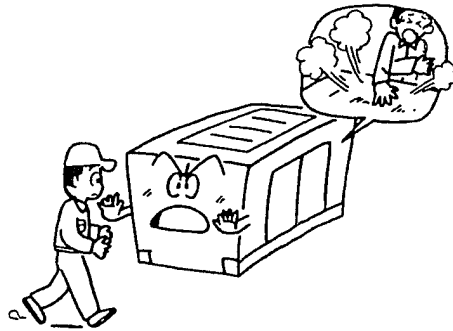
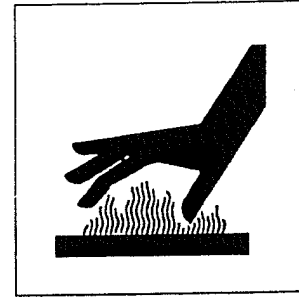

⚠ CAUTION BATTERY

- Battery generates flammable gases.
Improper handling may lead to explosion or serious
injury.
- * For maintenance of the machine, disconnect the cable on
the ground side.

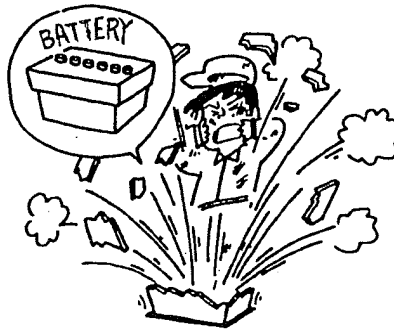
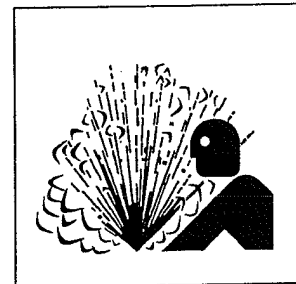

⚠ CAUTION Sign for maintenance

- * During checking or maintenance, be sure to put up a sign "Under maintenance" at a conspicuous place such as the starter switch to prevent the machine from being operated by other persons.

⚠ CAUTION Safety clothes

- * During checking or maintenance, be sure to put on suitable clothes and protectors.
- * Do not put on baggy clothes, necklace, etc., because they are easily caught by projections which may cause injuries.

⚠ CAUTION Handling of waste liquid

- * Waste liquid from the machine should be received in a vessel.
- * Do not dispose of waste liquid recklessly, as it causes environment pollution.
Do not throw it on the ground or in rivers, lakes, sea, etc.
- * Lubrication, fuel, cooling water (coolant) and other harmful objects such as filter, battery, etc., should be disposed of according to the related regulations.

8-1 Maintenance schedule

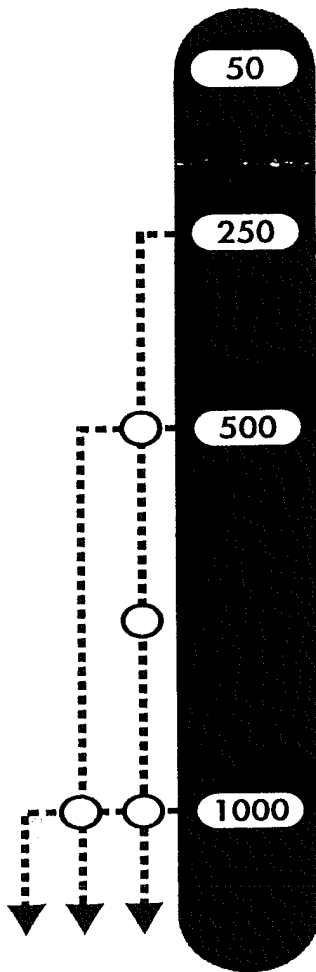

50 hours: Checking/first 50hours

- * Replacement of engine oil
- * Replacement of engine oil filter element

250 hours: Checking/every 250 hours

- * Replacement of engine oil
- * Replacement of engine oil filter element
- * Cleaning of air cleaner element
- * Measurement of generator insulation resistance (once a month)
- * Checking on battery specific gravity

500 hours: Checking/every 500 hours

- * Replacement of fuel filter cartridge
- * Cleaning of radiator
- * Inspection of injection nozzle
- * Checking for terminal and connection of the circuit
- * Checking/every 250 hours is also required.

1000 hours: Checking/every 1000 hours

- * Cleaning inside fuel tank
- * Replacement of air cleaner element
- * Adjustment of fuel injection timing
- * Checking on rubber suspension
- * Checking on nylon and rubber hose
- * Checking on lining
- * Checking/every 250 and 500 hours are also required.

On the engine system, main checking items only are shown in this manual.
For details, refer to the instruction manual for the engine furnished separately.

8-2 Checking/first 50 hours

(1) Replacement of engine oil

Replace the engine oil at 50 hours only first time and every 250 hours after second time.

- ① Remove the engine oil drain plug and discharge oil completely. It can be discharged easily when the engine is warm.
- ② After engine oil is discharged, tighten the plug firmly.
- ③ Charge new engine oil from the oil filler until it reaches the notched line of the "H" on the dipstick. For oil quantity, (See p. 45)
- ④ After engine oil is supplied, run the engine for a few minutes. Check that oil is supplied to the level between H and L. (See p. 34)

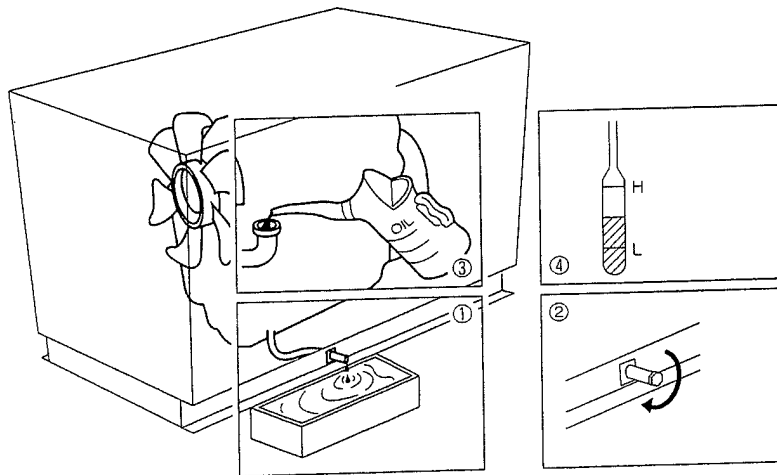

(2) Replacement of engine oil filter element

■ Element type (Element type separates filter case and element, so replace only the element.)

- ① Loosen the drain plug in the lower part of filter case and discharge the oil completely.
- ② Loosen the center bolt and remove the filter case, element and spring or the like.
- ③ Wash each parts except the element by washing oil.
- ④ Mount the element for replacement and O ring in reverse order. Tighten the center bolt in regulation torque certainly.
- ⑤ After the element is replaced, run the engine for a while. Then, check to see that oil is supplied to the level between H and L (See p.34).

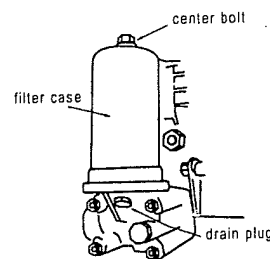

DCA-45SPI

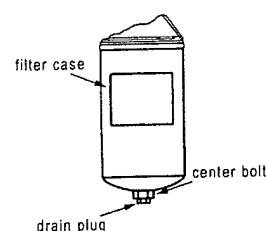

**DCA-60SPI
75SPI**

Parts number of oil filter cartridge :			
Model name	Parts number	manufacture	Parts number of manufacture
DCA-45SPI	06020 41107	ISUZU	187810-2201
DCA-60SPI	06020 41106	ISUZU	187810-0752
DCA-75SPI	06020 41106	ISUZU	187810-0752

8-3 Checking/every 250 hours

(1) Replacement of engine oil

Replacement is refer to 「8-2.(1) Replacement of engine oil See p.54」.

Excepting that the 45ESI unit should be at the interval of 500 hours.

(2) Replacement of engine oil filter element

Replacement is refer to 「8-2.(2) Replacement of engine oil filter element See p. 55」

(3) Cleaning of air cleaner element

This element should be cleaned, regardless of operating time, when the warning lamp of "Air filter blinding" goes on.

- Dry dust clings on element -

Remove the air cleaner element and clean the element with dry and clean compressed air.

- * While it is being cleaned, check the element for any damage. Replace if necessary.
- * Before installing the air cleaner, wipe off dirt on the element cover.
- * When insert the element, insert the element completely pressing equal edge of element.

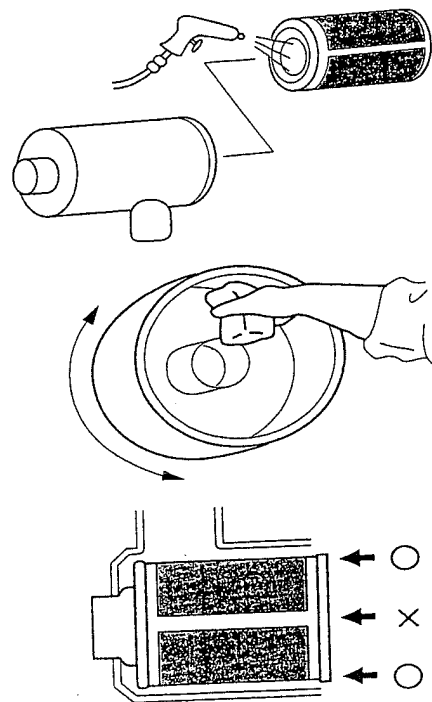

(4) Measurement of insulation resistance.

⚠ WARNING ELECTRIC SHOCK can kill.

* Measurement should be made after the machine stops.

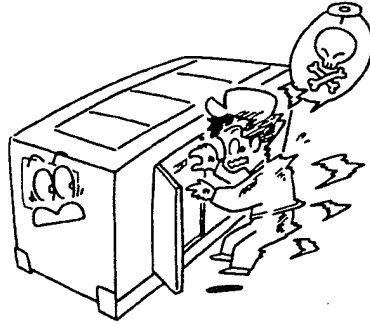

- Using a 500V megger, make a check once a month to ensure that the insulation resistance is more than 1M Ω .

Measurement:

Disconnect the load side cable from the output terminal as shown at below. Turn ON the circuit breaker and measure the insulation resistance between the output terminal bolt and the bonnet.

- If the measured resistance is less than 1M Ω , it may cause electric leakage or fire accident. Wipe off dirt and oil on the output terminals, circuit breakers and generator leads (cables) and dry them thoroughly.

If the insulation resistance is not recovered after cleaning, contact distributor or our office.

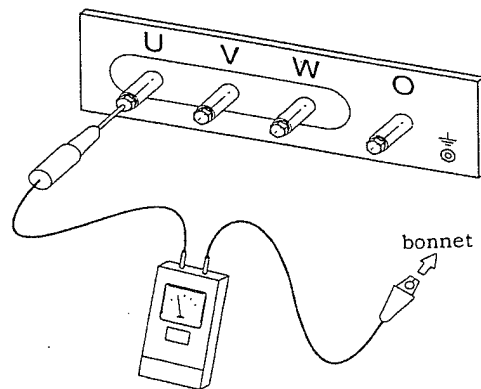

(5) Check on battery specific gravity.

If battery is likely to be discharged due to failure in startup of the engine, measure the specific gravity of battery acid.

The relation between battery charge condition (charging rate) and specific gravity is as shown below.

Charging rate (%)	Liquid temp. °C	20	0	-10
100		1.28	1.29	1.30
90		1.26	1.27	1.28
80		1.24	1.25	1.26
75		1.23	1.24	1.25

Each value has a deviation of ± 0.01 .

When the charging rate is below 75%, the battery needs to be recharged.

「7-1. Caution on battery charge See p. 48」

8-4 Checking/every 500 hours

Checking/every 250 hours is also required.

(1) Replacement of fuel filter cartridge.

- ① Remove the cartridge type element (cartridge) using filter wrench.
- ② Clean the filter base. Coat the packing of new cartridge with engine oil thin. Then, mount the cartridge.

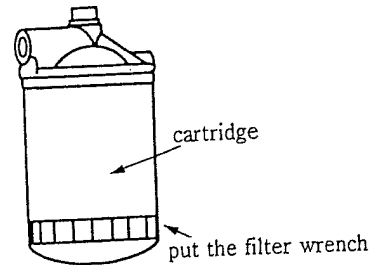

- When mounting, tighten the cartridge about from 1/2 to 3/4 turn by hand after the packing is fitted to the seal of the filter base.

- ③ After the cartridge is replaced, discharge air in the fuel piping.

- For details, refer to the instruction manual for the engine. A nameplate showing the method of discharging air is also attached to the machine.

Parts number of fuel filter cartridge :			
Model name	Parts number	manufacture	Parts number of manufacture
DCA-45SPI	06020 42407	ISUZU	113240-0791
DCA-60SPI	06020 42407	ISUZU	113240-0791
DCA-75SPI	06020 42407	ISUZU	113240-0791

(2) Cleaning of radiator and intercooler

When the fin or tube is blinded, it should be cleaned with steam or high pressure water.

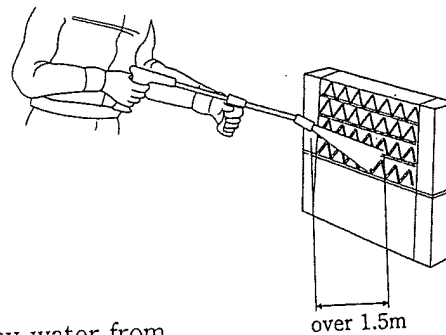

[Note]

When a high pressure washer is used, spray water from a place about 1.5m away to prevent damage to the fin or tube.

(3) Checking for terminal and connection of the circuit.

Check for main and sub circuit, whether there are no abnormality such as loosening, corrosion and burning, etc.

8-5 Checking/every 1000 hours

Checking/every 250 and 500 hours is also required.

(1) Cleaning inside fuel tank

Drain the fuel in the fuel tank completely, and wash out deposits and water collected inside the tank.

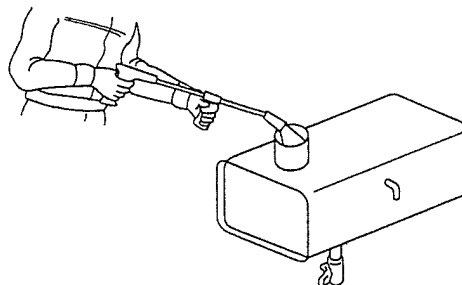

(2) Replacement of air cleaner element

The element should be replaced referring to "Cleaning of air cleaner element".

Parts number of air cleaner element :			
Model name	Parts number	manufacture	Parts number of manufacture
DCA-45SPI	06020 46610	DONALDSON	P81-1603
DCA-60SPI	06020 40193	DONALDSON	P10-4972
DCA-75SPI	06020 40193	DONALDSON	P10-4972

(3) Checking on rubber suspension

Check on the rubber suspension, whether it is damaged or deformed by the oil. Contact distributor or our office to replace the rubber suspension, if necessary.

(4) Checking on nylon and rubber hose

Check on the nylon and rubber hose, whether they are hardened or deteriorate. Contact distributor or our office to replace the nylon hose and rubber hose, if necessary.

(5) Checking on lining

Check on the lining, whether it deteriorates greatly, or it is stained by clinging of oil or the like, or it is removed. Contact distributor or our office to replace the lining, if necessary.

8-6 Table of periodical maintenance and checking

◇:Check or Clean ○:Replacement ☆:Only first time

	List of maintenance and inspection	daily	first 50h	every 250h	every 500h	every 1000	every 2years
Engine	Checking on oil level and stain of oil	◇					○
	Checking on cooling water	◇					
	Checking on fan belt	◇					
	Checking on fuel and drain	◇		◇			
	Checking on battery acid level	◇					
	Checking on for water and oil leakage	◇					
	Checking on bolts and nuts for looseness	◇					
	Checking on exhaust color, sound and vibration	◇					
	Checking on meters and warning lamps	◇					
	Replacement of engine oil		☆ ○	○			
	Replacement of engine oil filter		☆ ○	○			
	Clean air cleaner element			◇			
	Checking on specific gravity of battery			◇			
	Cleaning radiator				◇		
	Replacement of fuel filter					○	
	Cleaning fuel tank						◇
	Replacement of air cleaner element						○
	※ Inspection of engine valve clearance				☆ ◇		◇
	※ Adjust fuel injection nozzle						◇
	※ Inspection of timing of fuel injection						◇
Checking on rubber suspension						◇	
Checking on nylon and rubber hose						◇	
Checking on lining						◇	
Generator	Checking on generator case grounding	◇					
	Checking on insulation resistance			◇			
	Checking on terminal and connected section				◇		

※ Contact distributor or our office.

☆ This symbol represent first time of inspection, next time is ordinary schedule.

Inspection time is different by the engine,in detail, please refer "Engine Instruction Manual" furnished separately.

9. Troubleshooting

 **WARNING** MOVING PARTS can cause severe injury.

- Rotary unit which moving parts at a high speed is located in the machine.

Care should be taken during operation.

- * When the machine needs checking or maintenance, be sure to stop it in advance.

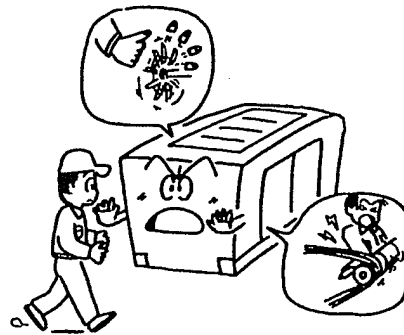
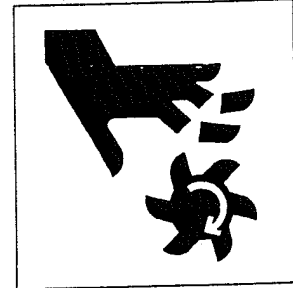

 **WARNING** ELECTRIC SHOCK can kill.

- High voltage units are located in the machine.

Care should be taken during operation.

- * When the machine needs checking or maintenance, be sure to stop it in advance.

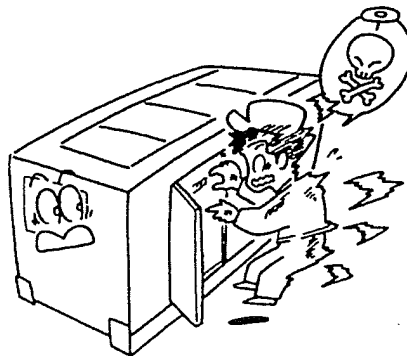

⚠ CAUTION HOT PARTS can burn skin.

- High temperature parts are located in the machine.
Care should be taken during operation.
- * When the machine needs inspection or maintenance,
be sure to stop it in advance.
- * Even after the machine stops, the inside of the
bonnet is still hot.
Wait until the engine is cooled sufficiently.

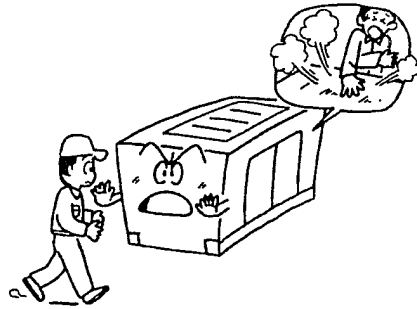
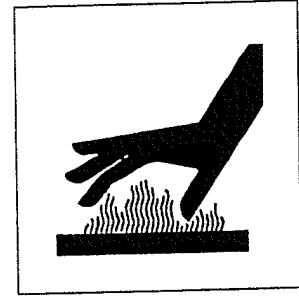

⚠ CAUTION Handling of BATTERY

- Battery generates flammable gases.
Improper handling may lead to explosion or serious
injury.
- * For maintenance of the machine, disconnect the ground cable.

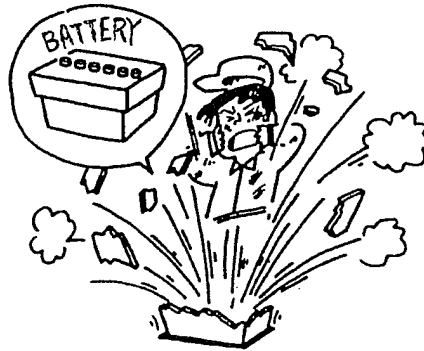
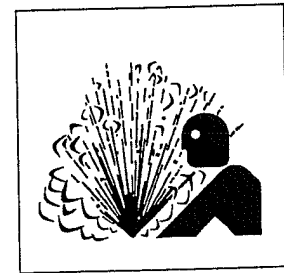

Phenomenon		Assumed cause	Action
Engine will not start up	Cell motor will not run or revolution speed is low	Discharged battery	Charge or replace
		Detached or loosened or corroded battery terminal	Repair
		Battery switch set at OFF position	Turn ON
		Improper starter switch	Replace
		Improper starter	Replace
		Broken lead wire	Repair
	Cell motor runs	Fuel shortage	Supply
		Blinded fuel filter	Replace element
		Air in fuel system	Remove
	Speed will not rise	Air in fuel system	Remove
Blinded fuel filter		Replace element	
Compression failure		Repair engine	
Blinded air cleaner		Replace element	
Engine stop by oil failure	Oil shortage	Supply	
	Oil pressure switch failure	Replace	
	Blinded oil filter	Replace element	
Over heat (water temperature)	Cooling water shortage	Supply	
	Fan belt looseness	Adjust	
	Blinded core of radiator	Clean	
	Engine thermostat failure	Repair	
Voltmeter will not operate	Voltmeter failure	Replace	
	AVR failure	Contact distributor or our office	
	Burned ZNR		
	Quenched residual magnetism		
	Burned rotary rectifier		
	Disconnected rotor wiring		
Burned generator wiring			
Rated voltage will not be reached	Voltmeter failure	Replace	
	AVR failure	Contact distributor or our office	
	VR failure		
	Burned rotary rectifier		
	Burned ZNR		
	Burned generator wiring		
	Low speed	Increase	

Phenomenon	Assumed cause	Action
Voltage goes too high	Voltmeter failure	Replace
	AVR failure	Contact distributor or our office
	VR failure	
Applied load causes load voltage drop	Burned rotary rectifier	Contact distributor or our office
	AVR failure	
	Burned main field, exciter field wiring	
	Unbalanced load	Balance

10. Long-term storage

When the machine is to be stored for a long period of time, choose a cool place free from moisture and dust, and observe the following points.

- (1) Remove dirt clinged the machine and clean it thoroughly.
If painting is peeled off, it should be repaired.
- (2) Remove the battery from the machine. The battery should be charged completely before it is stored.
 - Battery is discharged of itself. Recharge it once a month.
- (3) If any defects are found, check and repair the machine so that it can be used for future operation.
- (4) For details of handling the engine, refer to the instruction manual for the engine provided separately.

CAUTION

Stacking

- Improper stacking of machines may cause falling or dropping accidents.

When stacking other machines on this machine, be sure to observe the following points.

- * Check that the bonnet of the machine is free from damage and that the fixing bolts are not loosened and missing.
- * Put the machine horizontally on a solid foundation which withstands the weight of stacked machines.
- * Machines can be stacked up to 2 stages. The weight and size of stacked machines should be less than those of this machine.
- * Using square timbers as shown below, put each machine making sure that the weight is even.

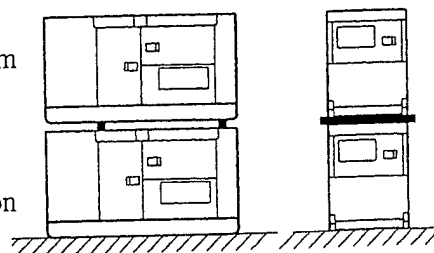

- Do not operate the machines in the state of stacking to prevent falling or dropping accidents.

11. Service data

11-1 Specifications

MODEL		DCA-45SPI	DCA-60SPI	DCA-75SPI	
A C G E N E R A T O R	MODEL	DB-0501I	DB-0661I	DB-0831I	
	FREQUENCY	50 / 60 Hz			
	RATED OUTPUT	37 / 45 kVA 29.6 / 36 kW	50 / 60 40 / 48	65 / 75 52 / 60	
	RATED VOLTAGE	200 / 220 V			
	RATED CURRENT	107 / 118 A	144 / 157	188 / 197	
	POWER FACTOR	0.8 (lagging)			
	NO. OF PHASES	Three-phase (four wire)			
	EXCITATION	Brushless type (with automatic voltage regulator)			
	NO. OF POLES	4			
	SPEED	1500 / 1800 min ⁻¹ (rpm)			
	INSULATION	class F			
	MANUFACTURE	ISUZU			
	E N G I N E	MODEL	B-4BG1	A-6BG1	
		TYPE	4-cycle water cooled diesel engine direct injection type		
NO. OF CYLINDERS		4-	6-		
BORE × STROKE (mm)		105×125	105×125		
TOTAL DISPLACEMENT		4.329 L	6.494		
RATED OUTPUT (1500/1800min ⁻¹)		34.2/41.2 kW 46.5 / 56 PS	47.1 / 57.4 64 / 78	58.8 / 68.4 80 / 93	
BATTERY (DOMESTIC STANDARD)		65D31R × 2		95E41R × 2	
FUEL		DIESEL FUEL ASTM No. 2 or equivalent			
FUEL TANK CAP.		100 L	125	155	
ENGINE OIL *1		OVERALL	14.0 L	19.3	
		FILTER	0.7 L	1.0	
COOLANT QUANTITY*2		OVERALL	13.9 L	19.0	22.9
		RESERVE TANK	1.0 L	1.0	2.4
S E T		LENGTH OVERALL	2000 mm	2420	2630
	WIDTH OVERALL	880 mm	880	1000	
	HEIGHT	1250 mm	1250	1300	
	DRY WEIGHT	1180 kg	1410	1590	
	TOTAL WEIGHT	1340 kg	1610	1780	

The above specifications and set dimensions are subject to change.

*1 Overall of engine oil contains filter.

*2 Overall of coolant quantity contains reserve tank.

Dry weight : This weight does not contain the cooling water, engine oil and fuel.

Total weight : This weight contains the cooling water, engine oil and fuel.

11-2 AC generator specifications (for custom voltage)

DCA-45SPI		50Hz				60Hz			
Rated output	kVA	37	37	37	33.3	40.5	45	45	45
	kW	29.6	29.6	29.6	26.6	32.4	36	36	36
Rated voltage (V)		190/380	400	415	220/440	190/380	200/400	440	240/480
Rated current (A)		112/56.2	53.4	51.5	87.4/43.7	123/61.5	130/65.0	59.0	108/54.1

DCA-60SPI		50Hz				60Hz			
Rated output	kVA	50	50	50	45	54	60	60	60
	kW	40	40	40	36	43.2	48	48	48
Rated voltage (V)		190/380	400	415	220/440	190/380	200/400	440	240/480
Rated current (A)		152/76.0	72.2	69.6	118/59.0	164/82.0	173/86.6	78.7	144/72.2

DCA-75SPI		50Hz				60Hz			
Rated output	kVA	65	65	65	58.5	67.5	75	75	75
	kW	52	52	52	46.8	54	60	60	60
Rated voltage (V)		190/380	400	415	220/440	190/380	200/400	440	240/480
Rated current (A)		198/98.8	93.8	90.4	154/76.8	205/103	217/108	98.4	180/90.2

DCA-60SPI

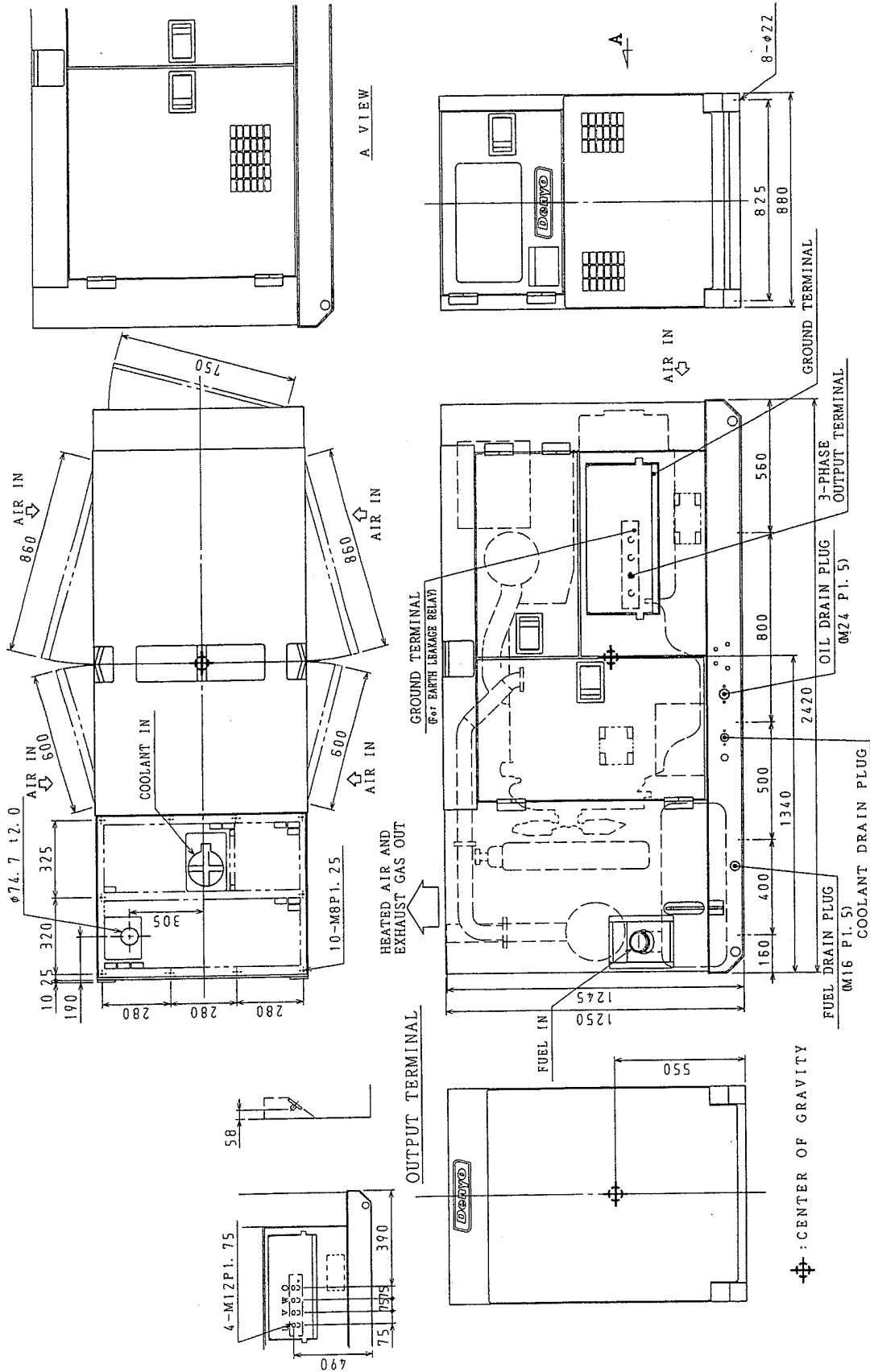

⊕ : CENTER OF GRAVITY

11-4 Generator connection diagram DCA-45SPI

MARK	N	A	M	E
Ar				MAIN GENERATOR ARMATURE WINDING
Fg				MAIN GENERATOR FIELD WINDING
ExAt				EXCITER ARMATURE WINDING
ExFg				EXCITER FIELD WINDING
Re				RECTIFIER
AVR				AUTOMATIC VOLTAGE REGULATOR
VR				VOLTAGE REGULATING RHEOSTAT
CT1,3				CURRENT TRANSFORMER 150/5A
AS				AMMETER CHANGE-OVER SWITCH
A				AC. AMMETER 0~75, 150A
VS				VOLTMETER CHANGE-OVER SWITCH
V				AC. VOLTMETER 0~600V
F				FREQUENCY METER 45~65Hz
PL1				PILOT LAMP
CB1				CIRCUIT BREAKER 175A
SW1				PANEL LIGHT SWITCH
OC				OVER CURRENT RELAY
Z2				LEAKAGE CURRENT RELAY
C				CONDENSER
COT. B				VOLTAGE CHANGE-OVER BOARD

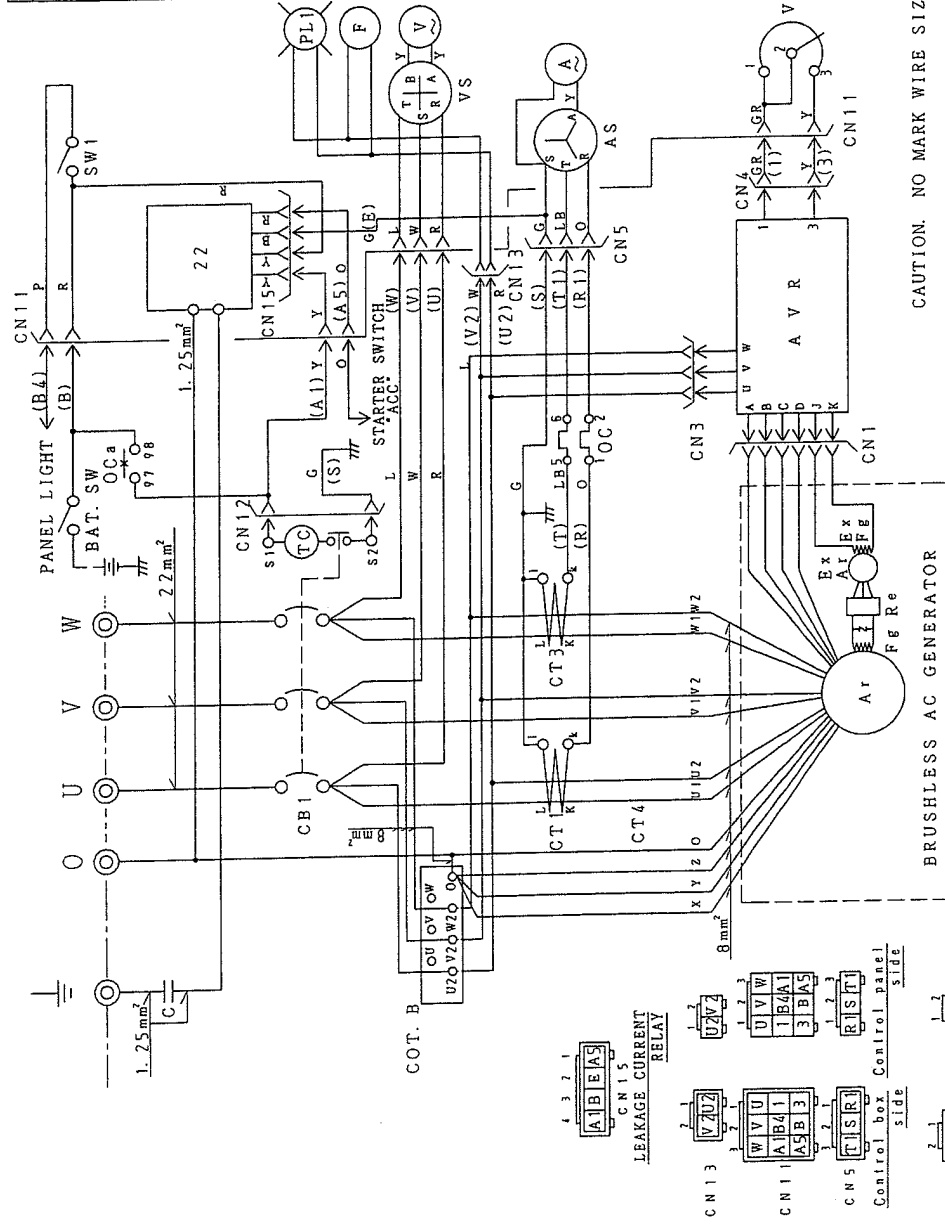

VOLTAGE CHANGE-OVER

FROM CB1
U V W

FROM COT. B
U V W

380, 400/440 V set 200/220 V set

COLOR CODE

WIRE COLOR	WIRE COLOR
B BLACK	R RED
L BLUE	W WHITE
BR BROWN	Y YELLOW
G GREEN	LB LIGHT BLUE
GR GRAY	LG LIGHT GREEN
V VIOLET	O ORANGE
P PINK	

CAUTION. NO MARK WIRE SIZE: 1.25mm²

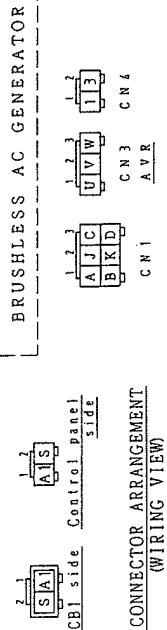

DCA-60SPI

MARK	N A M E
AT	MAIN GENERATOR ARMATURE WINDING
FG	MAIN GENERATOR FIELD WINDING
ExAt	EXCITER ARMATURE WINDING
ExFg	EXCITER FIELD WINDING
Re	RECTIFIER
AVR	AUTOMATIC VOLTAGE REGULATOR
VR	VOLTAGE REGULATING RHEOSTAT
CT1, 3	CURRENT TRANSFORMER 200/5A
AS	AMMETER CHANGE-OVER SWITCH
A	AMMETER 0 ~ 100.200A
VS	VOLTMETER CHANGE-OVER SWITCH
V	AC. VOLTMETER 0 ~ 600V
F	FREQUENCY METER 45 ~ 65Hz
PL1	PILOT LAMP
CB1	CIRCUIT BREAKER 150A
SW1	PANEL LIGHT SWITCH
OC	OVER CURRENT RELAY
Z2	LEAKAGE CURRENT RELAY
C	CONDENSER
COT. B1	VOLTAGE CHANGE-OVER BOARD

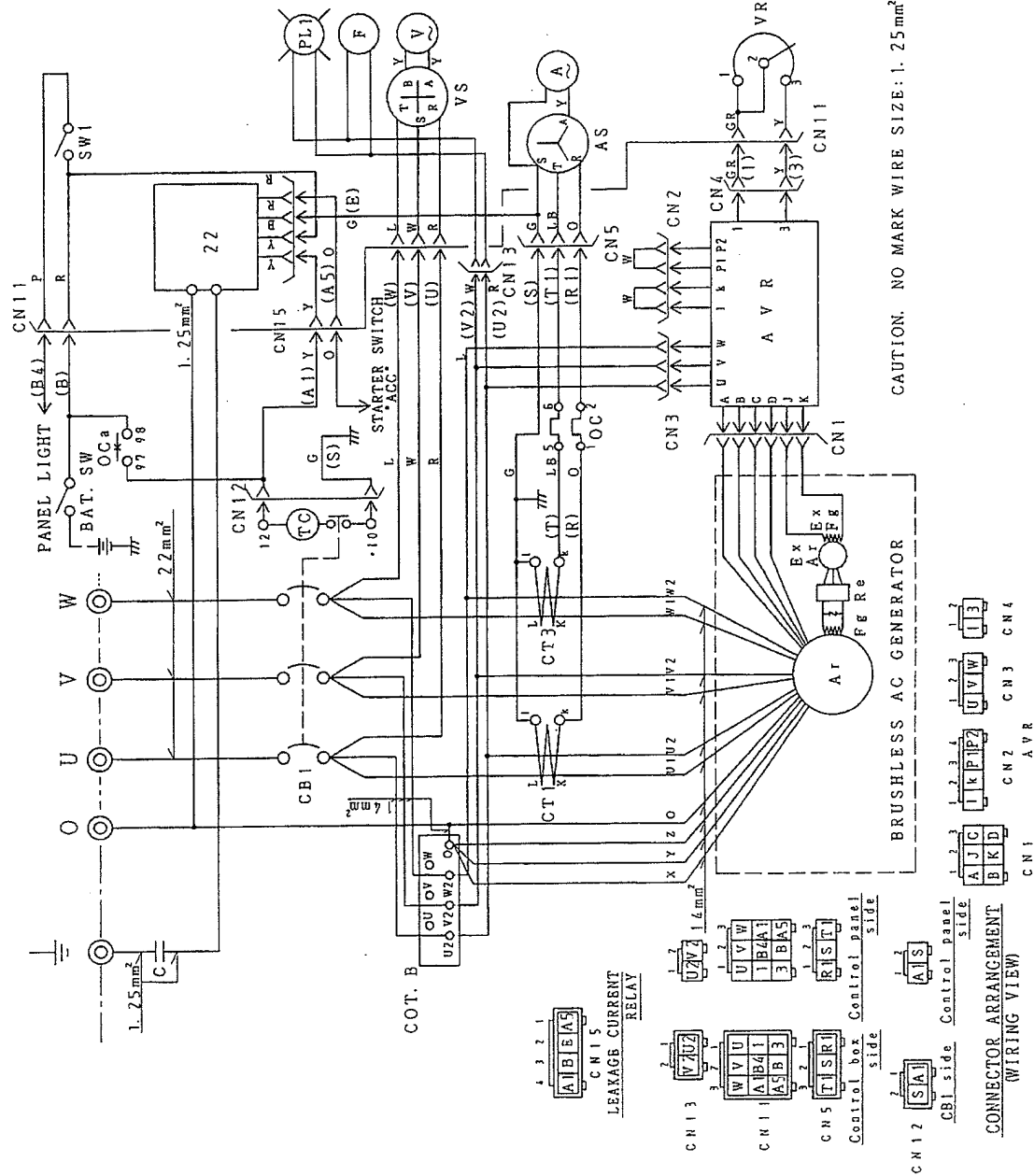

VOLTAGE CHANGE-OVER

FROM CBI
U V W COT. B

FROM CBI
U V W COT. B

380. 400/440 V set 200/220 V set

WIRE COLOR	WIRE COLOR
B BLACK	R RED
L BLUE	W WHITE
BR BROWN	Y YELLOW
C GREEN	LB LIGHT BLUE
GR GRAY	LG LIGHT GREEN
V VIOLET	O ORANGE
P PINK	

CAUTION. NO MARK WIRE SIZE: 1.25 mm²

DCA-75SPI

MARK	N	A	M	E
Ar				MAIN GENERATOR ARMATURE WINDING
Fg				MAIN GENERATOR FIELD WINDING
ExAr				EXCITER ARMATURE WINDING
ExFg				EXCITER FIELD WINDING
Re				RECTIFIER
AVR				AUTOMATIC VOLTAGE REGULATOR
VR				VOLTAGE REGULATING RHEOSTAT
CT1,3				CURRENT TRANSFORMER 200/5A
AS				AMMETER CHANGE-OVER SWITCH
A				AC. AMMETER 0~125, 250A
VS				VOLTMETER CHANGE-OVER SWITCH
V				AC. VOLTMETER 0~600V
F				FREQUENCY METER 45~65Hz
PL1				PILOT LAMP
CB1				CIRCUIT BREAKER 200A
SW1				PANEL LIGHT SWITCH
OC				OVER CURRENT RELAY
Z2				LEAKAGE CURRENT RELAY
C				CONDENSER
COT. B				VOLTAGE CHANGE-OVER BOARD

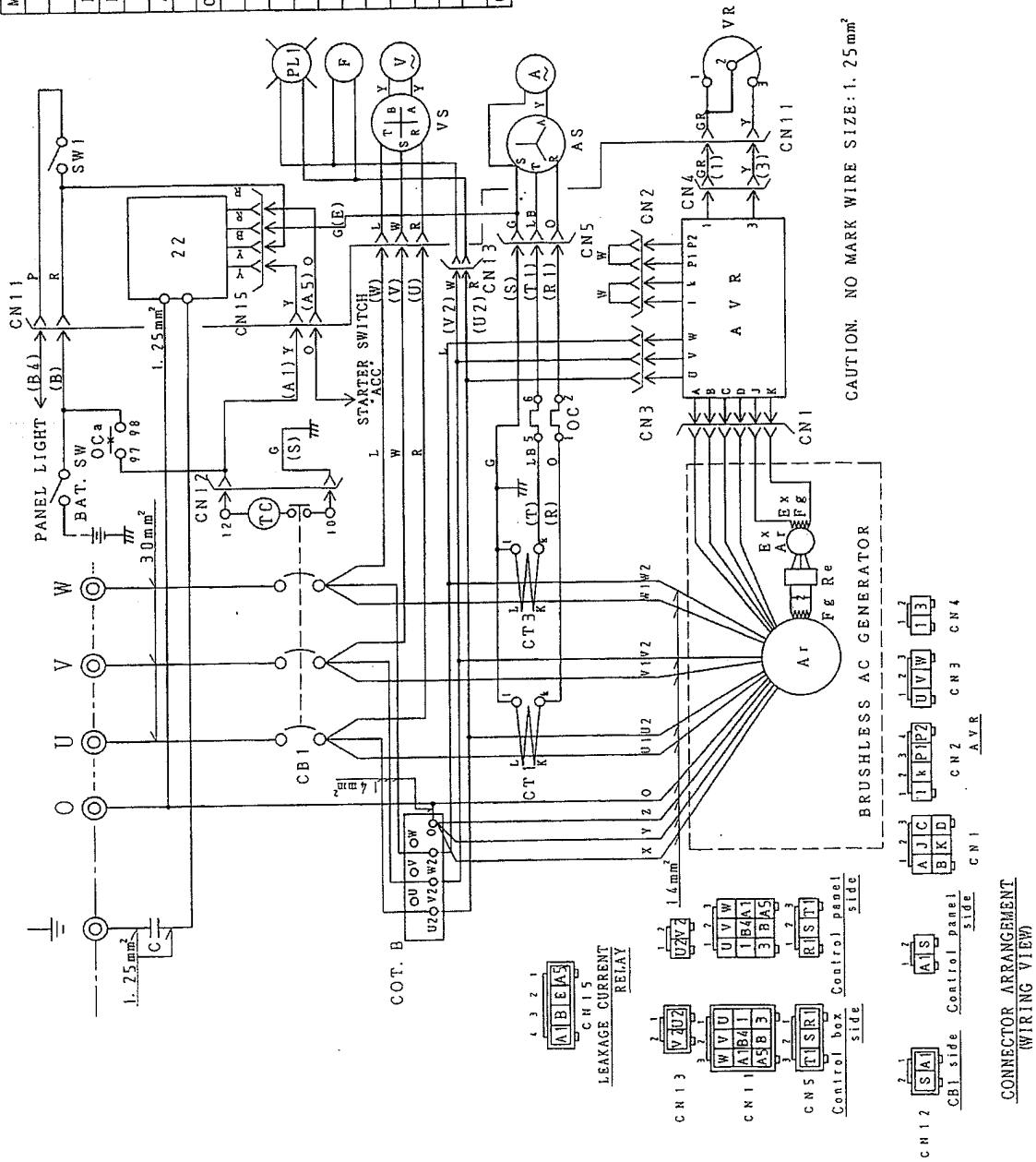
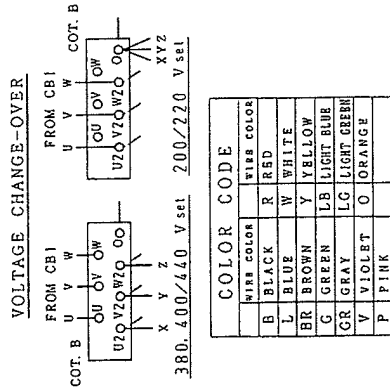

DCA-60SPI,-75SPI

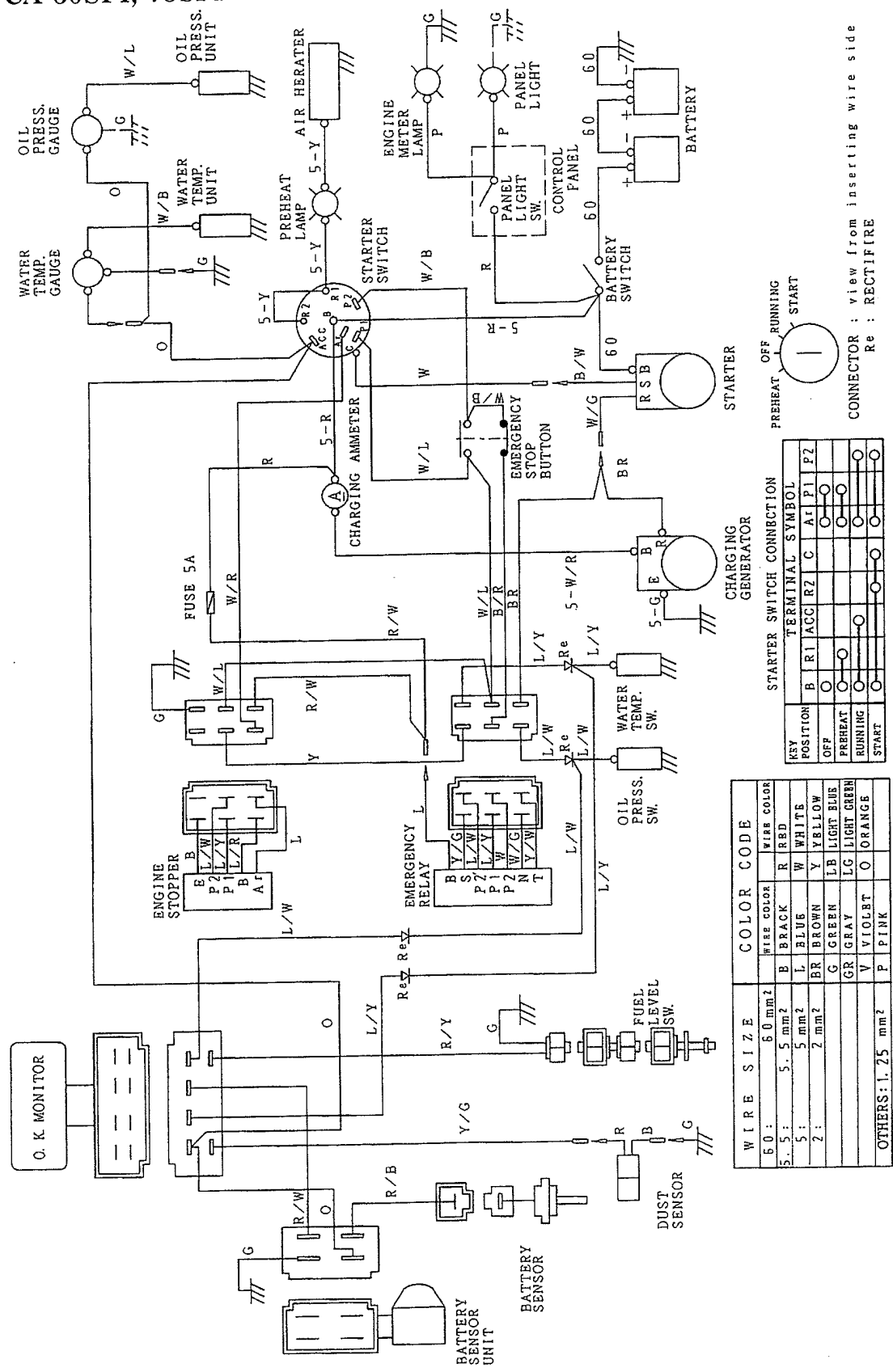

WIRE SIZE	COLOR CODE	WIRE COLOR	WIRE COLOR
6.0		B	BLACK
5.5		L	BLUE
5		BR	BROWN
2		G	GREEN
		GR	GRAY
		V	VIOLET
		P	PINK
OTHERS: 1. 25 mm ²			

KEY POSITION	B	R	I	ACC	R2	C	A1	P1	P2
OFF	○	○	○	○	○	○	○	○	○
PREHEAT	○	○	○	○	○	○	○	○	○
RUNNING	○	○	○	○	○	○	○	○	○
START	○	○	○	○	○	○	○	○	○

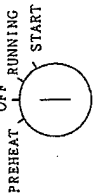

CONNECTOR : view from inserting wire side
Re : RECTIFIERS

