

STIHL[®]

STIHL BT 360

Instruction Manual



Contents

Guide to Using this Manual	2
Safety Precautions and Working Techniques	2
Assembling the Unit	7
Fuel	10
Fueling	11
Starting / Stopping the Engine	12
Fitting the Auger	14
Operating Instructions	14
Releasing a Trapped Auger	15
Cleaning the Air Filter	15
Adjusting the Carburetor	16
Spark Plug	16
Engine Running Behavior	17
Lubricating the Gearbox	17
Rewind Starter	18
Storing the Machine	18
Maintenance and Care	19
Minimize Wear and Avoid Damage	21
Main Parts	22
Specifications	23
Special Accessories	24
Maintenance and Repairs	24
Disposal	24
EC Declaration of Conformity	25

Dear Customer,

Thank you for choosing a quality engineered STIHL product.

It has been built using modern production techniques and comprehensive quality assurance. Every effort has been made to ensure your satisfaction and troublefree use of the product.

Please contact your dealer or our sales company if you have any queries concerning this product.

Your



Dr. Nikolas Stihl



BT 360

This instruction manual is protected by copyright. All rights reserved, especially the rights to reproduce, translate and process with electronic systems.

Guide to Using this Manual

Pictograms

All the pictograms attached to the machine are shown and explained in this manual.

Symbols in text



WARNING

Warning where there is a risk of an accident or personal injury or serious damage to property.



NOTICE

Caution where there is a risk of damaging the machine or its individual components.

Engineering improvements

STIHL's philosophy is to continually improve all of its products. For this reason we may modify the design, engineering and appearance of our products periodically.

Therefore, some changes, modifications and improvements may not be covered in this manual.

Safety Precautions and Working Techniques



Special safety precautions must be observed when working with this power tool because of its high torque and the high speed of the auger in certain applications, and because the augers have sharp edges.



It is important you read and understand the instruction manual before first use and keep the manual in a safe place for future reference. Non-observance of the instruction manual may result in serious or even fatal injury.



Observe all application local safety regulations, standards and ordinances.

If you have not used this type of power tool before: Have your dealer or other experienced user show you how to operate your power tool or attend a special course in its operation.

Minors should never be allowed to use a power tool.

Keep bystanders, especially children, and animals away from the work area.

When the power tool is not in use, shut it off so that it does not endanger others. Secure it against unauthorized use.

The user is responsible for avoiding injury to third parties or damage to their property.

Do not lend or rent your power tool without the instruction manual. Be sure that anyone using it understands the information contained in this manual.

The use of noise emitting power tools may be restricted to certain times by national or local regulations.

To operate the power tool you must be rested, in good physical condition and mental health.

If you have any condition that might be aggravated by strenuous work, check with your doctor before operating a power tool.

Persons with pacemakers only: The ignition system of your power tool produces an electromagnetic field of a very low intensity. This field may interfere with some pacemakers. STIHL recommends that persons with pacemakers consult their physician and the pacemaker manufacturer to reduce any health risk.

Do not operate the power tool if you are under the influence of any substance (drugs, alcohol) which might impair vision, dexterity or judgment.

Use your the power tool only for drilling holes in soil – depending on the assigned drilling tools.

It must not be used for any other purpose because of the increased risk of accidents and damage to the machine.

Before drilling, make sure there are no buried power cables or supply pipes in the work area (e.g. for gas, water, electricity):

- Contact your local utility company for information on cable and pipe locations.
- Where necessary, confirm actual location with cable detectors and/or by carefully dug trenches.

Only use drilling tools and accessories that are explicitly approved for this power tool by STIHL or are technically identical. If you have any questions in this respect, consult a servicing dealer. Use only high quality parts and accessories in order to avoid the risk of accidents and damage to the machine.

STIHL recommends the use of original STIHL replacement parts. They are specifically designed to match your model and meet your performance requirements.

Never attempt to modify your unit in any way since this may increase the risk of personal injury. STIHL excludes all liability for personal injury and damage to property caused while using unauthorized attachments.

Do not use a pressure washer to clean the power tool. The solid jet of water may damage parts of the power tool.

Clothing and Equipment

Wear proper protective clothing and equipment.



Clothing must be sturdy but allow complete freedom of movement. Wear snug-fitting clothing, an overall and jacket combination, do not wear a work coat.

Avoid clothing that could get caught on branches or brush or moving parts of the machine. Do not wear a scarf, necktie or jewelry.



Tie up and confine long hair (e.g. with a hair net, cap, hard hat, etc.).

Wear steel-toed safety boots with non-slip soles.



Wear safety glasses or other suitable eye protection. Wear hearing protection, e.g. earplugs or ear muffs.

Wear a safety hard hat where there is a danger of head injuries from falling objects.



Wear heavy-duty work gloves made of durable material (e.g. leather).

STIHL offers a comprehensive range of personal protective clothing and equipment.

Transporting the Power Tool

Always turn off the engine.

The power tool should be carried by two persons by the handle frame.

Remove the auger before transporting the power tool long distances. To **reduce the risk of burn injury**, carry the unit by the handle frame with hot parts of the machine (e.g. gearbox, muffler) away from your body.

Allow the unit to cool down before transporting it by vehicle.

Transporting in a vehicle: Properly secure your power tool to prevent turnover, fuel spillage and damage.

Fueling



Gasoline is an extremely flammable fuel. Keep clear of naked flames. Do not spill any fuel – do not smoke.

Always **shut off the engine** before refueling.

Do not fuel a hot engine – **fuel may spill and cause a fire.**

Open the fuel cap carefully to allow any pressure build-up in the tank to release slowly and avoid fuel spillage.

Fuel your power tool only in well-ventilated areas. If you spill fuel, wipe the machine immediately – if fuel gets on your clothing, change immediately.



After fueling, tighten down the screw-type fuel cap as securely as possible.

English

This reduces the risk of unit vibrations causing the fuel cap to loosen or come off and spill quantities of fuel.

To reduce the risk of serious or fatal burn injuries, check for fuel leakage. If fuel leakage is found, do not start or run the engine until leak is fixed.

Before Starting

Unfold the handle frame and make sure it is properly locked in the working position – see "Assembling the Machine".

Check that your power tool is properly assembled and in good condition – refer to appropriate chapters in the instruction manual.

- Check the fuel system for leaks, paying special attention to visible parts such as the tank cap, hose connections and the manual fuel pump (on machines so equipped). If there are any leaks or damage, do not start the engine **risk of fire**. Have your machine repaired by a servicing dealer before using it again.
- Stop switch on powerhead must move easily to **STOP** and stop switch on handlebar must move easily to **0**.
- Smooth action of throttle lever – it must return automatically to idle position.
- Throttle cable properly positioned – see "Assembling the Machine", "Fitting the Throttle Cable".

- Check that the spark plug boot is secure – a loose boot may cause arcing that could ignite combustible fumes **and cause a fire**.
- Never attempt to modify the controls or safety devices in any way.
- Keep the handles dry and clean – free from oil and dirt – for safe control of the power tool.
- Check that handle hoses on handlebars and coating on throttle lever are in good condition.

To reduce the risk of personal injury, do not operate your power tool if it is damaged or not properly assembled.

Starting the Engine

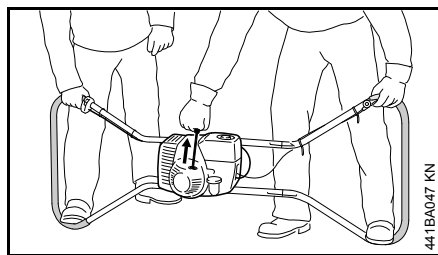

Start the engine at least 3 meters from the fueling spot, outdoors only.

Do not start the engine with the auger in the spindle. The machine must be operated by 2 persons and may be started only when it is held steady by the operating crew.

Do not allow other persons in the work area – even when starting.

Start the engine as described in the instruction manual.

Note that the drilling spindle continues to rotate for a short period after you let go of the throttle trigger (flywheel effect).

To reduce the risk of injury, never use drilling tools or augers that are longer than 1 meter.

Place the unit on level ground, make sure you have secure footing, hold the unit securely.

Check idle speed setting: The drilling tool must not rotate when the engine is idling with the throttle lever released.

To reduce the risk of fire, keep hot exhaust gases and hot muffler away from easily combustible materials (e.g. wood chips, bark, dry grass, fuel).

Holding and Controlling the Power Tool

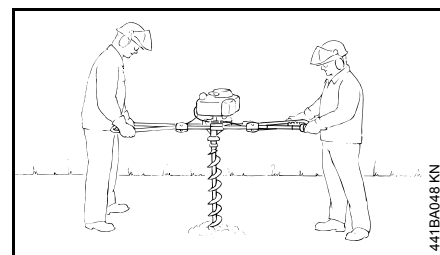

The machine is operated by two persons. They must hold the handle frame firmly with both hands

Make sure you always have good balance and secure footing.

Wrap your fingers and thumbs around the handles.

During Operation

Good and clear communications between the operators reduces the risk of injury. Instructions and directions may be given only by the person who is controlling the throttle lever.

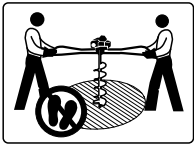

To reduce the risk of injury, keep work area around power tool clear of obstacles.

The auger may jam in the hole, especially when working in rocky ground or ground with a heavy root structure. In such a case the power tool may begin to rotate around the jammed auger – shut off the engine immediately.

Always keep feed pressure and auger speed at a level that suits conditions and clear the hole frequently by lifting the auger slightly.

In the event of impending danger or in an emergency, switch off the engine immediately by moving the stop switch on the powerhead to **STOP** or the stop switch on the handlebar to **0**.

Note that the drilling spindle continues to rotate for a short period after you let go of the throttle trigger (flywheel effect).

Do not touch a hot muffler – operate the machine only with the muffler guard securely mounted in position.

Do not allow any other persons in the work area. **To reduce the risk of injury**, keep a sufficiently safe distance away from other persons.

Make sure that the idle speed is properly adjusted: The drilling tool must stop rotating, after a brief delay, when you release the throttle lever. If the drilling tool continues to rotate when the engine is idling, have the machine checked by your servicing dealer. Check and correct the idle speed setting regularly.

Take special care in slippery conditions – damp, snow, ice, on slopes or uneven ground.

Watch out for obstacles: Roots, tree stumps or holes which could cause you to trip or stumble.

Make sure you always have good balance and secure footing.

Be particularly alert and cautious when wearing hearing protection because your ability to hear warnings (shouts, alarms, etc.) is restricted.

To reduce the risk of accidents, take a break in good time to avoid tiredness or exhaustion.

Work calmly and carefully – in daylight conditions and only when visibility is good. Stay alert so as not to endanger others.



Your power tool produces toxic exhaust fumes as soon as the engine is running. These fumes may be colorless and odorless and contain unburned hydrocarbons and benzol. Never run the engine indoors or in poorly ventilated locations, even if your model is equipped with a catalytic converter.

To reduce the risk of serious or fatal injury from breathing toxic fumes, ensure proper ventilation when working in trenches, hollows or other confined locations.

To reduce the risk of accidents, stop work immediately in the event of nausea, headache, visual disturbances (e.g. reduced field of vision), problems with hearing, dizziness, deterioration in ability to concentrate. Apart from other possibilities, these symptoms may be caused by an excessively high concentration of exhaust gases in the work area.

Operate your power tool so that it produces a minimum of noise and emissions – do not run the engine unnecessarily, accelerate the engine only when working.

To reduce the risk of fire, do not smoke while operating or standing near your power tool. Note that combustible fuel vapor may escape from the fuel system.

If your power tool is subjected to unusually high loads for which it was not designed (e.g. heavy impact or a fall), always check that it is in good condition before continuing work – see also "Before Starting". Check the fuel system in particular for leaks and make sure the safety devices are working properly. Do not continue operating your power tool if it is damaged. In case of doubt, have the unit checked by your servicing dealer.

Do not operate your saw with the starting throttle lock engaged.

When taking the auger out of the hole, lift the machine vertically so that the tool comes out straight without canting.

To reduce the risk of injury, do not touch the auger or drilling spindle unless the engine is stopped and the auger is at a standstill.



Avoid contact with electrical cables or wires – **risk of electric shock**.

Hold the machine firmly in order to control sudden jolts and reactive forces – keep feed pressure relatively low.



Work particularly carefully in rocky ground or ground with a heavy root structure.

Cover and clearly mark boreholes.

To reduce the risk of injury, shut off the engine before changing the auger.

To avoid serious burn injuries, avoid touching hot parts of the machine, especially the muffler.

Before leaving the power tool unattended: Shut off the engine.

Check condition of augers regularly. Replace damaged or dull augers immediately.

The power tool is designed to produce the best results when the vibrations felt by the user are lowest. If you notice an increase in vibrations while you are working, reduce speed on the throttle lever to achieve greater drilling efficiency.

Vibrations

Prolonged use of the power tool may result in vibration-induced circulation problems in the hands (whitefinger disease).

No general recommendation can be given for the length of usage because it depends on several factors.

The period of usage is prolonged by:

- Hand protection (wearing warm gloves)
- Work breaks

The period of usage is shortened by:

- Any personal tendency to suffer from poor circulation (symptoms: frequently cold fingers, tingling sensations).
- Low outside temperatures.
- The force with which the handles are held (a tight grip restricts circulation).

Continual and regular users should monitor closely the condition of their hands and fingers. If any of the above symptoms appear (e.g. tingling sensation in fingers), seek medical advice.

Maintenance and Repairs

Service the machine regularly. Do not attempt any maintenance or repair work not described in the instruction manual. Have all other work performed by a servicing dealer.

STIHL recommends that you have servicing and repair work carried out exclusively by an authorized STIHL servicing dealer. STIHL dealers are regularly given the opportunity to attend training courses and are supplied with the necessary technical information.

Only use high-quality replacement parts in order to avoid the risk of accidents and damage to the unit. If you have any questions in this respect, consult a servicing dealer.

STIHL recommends the use of original STIHL replacement parts. They are specifically designed to match your model and meet your performance requirements.

To reduce the risk of injury, **always shut off the engine** before carrying out any maintenance or repairs or cleaning the machine. – Exception: Carburetor and idle speed adjustments.

Do not turn the engine over on the starter with the spark plug boot or spark plug removed unless the stop switch on the powerhead is on **STOP** or the stop switch on the handlebar is on **0** since there is otherwise a **risk of fire** from uncontained sparking.

To reduce the **risk of fire**, do not service or store your machine near open flames.

Check the fuel filler cap for leaks at regular intervals.

Use only a spark plug of the type approved by STIHL and make sure it is in good condition – see "Specifications".

Inspect the ignition lead (insulation in good condition, secure connection).

Check the condition of the muffler.

To reduce the risk of fire and damage to hearing, do not operate your machine if the muffler is damaged or missing. –

Do not touch a hot muffler since burn injury will result.

Assembling the Unit

Mounting the Inner Sections

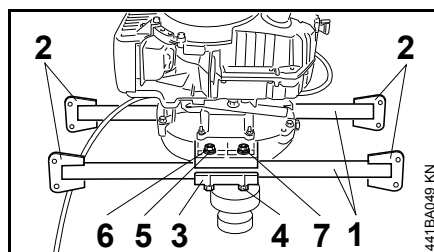

- Position the two inner sections (1) against the underside of the gearbox. Make sure the off-center hinge plates (2) are on the outboard sides of the tubes.
- Fit the clamps (3) and line up the holes.
- Insert the M10x75 hex head screws (4) from below.
- Fit the plain washers (5) and spring washers (6).
- Screw on the nuts (7) and tighten them down firmly.

Preparing the Retainers

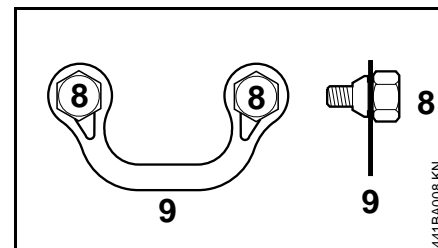

- Fit two hex head screws (8) in each of the retainers (9) – make sure the retainer engages the groove in the hex head screw.

Mounting the Handlebars

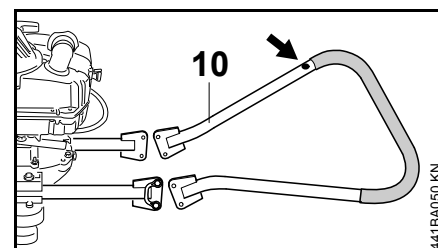

- Mount the handlebars so that the hole (arrow) in the handlebar (10) is on the right – viewed from the operator.

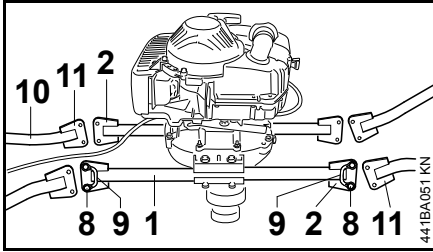

- Position the hinge plates (11) of the handlebars (10) against the hinge plates (2) on the inner sections (1) and line up the holes.
- Place the hex head screws (8) with retainer (9) in position.
- Insert the hex head screws (8) and tighten them down firmly.

If throttle lever is not preassembled

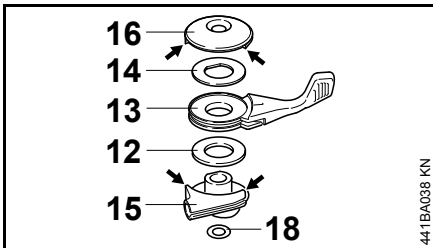

- Fit the washer (12), lever (13) and washer (14) on the guide (15) as shown.
- Fit the cap (16), making sure its two stop lugs (arrows) engage the stop lugs (arrows) on both sides of the guide (15).

- Insert the M6x55 countersunk screw through the cap (16), washer (14), lever (13), washer (12) and guide (15).
- Fit the washer (18) – it holds the preassembled throttle lever together.

Mounting the Throttle Lever

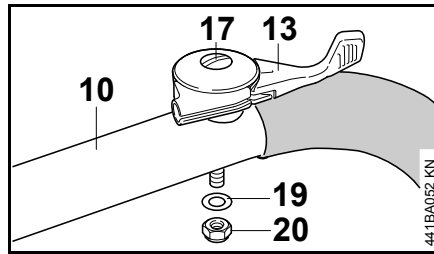

- Insert countersunk screw (17) with preassembled throttle lever through the hole in the handlebar (10).
- Fit the washer (19).
- Screw on the nut (20) and tighten it down firmly – the throttle lever (13) must move freely.

Fitting the Throttle Cable

Use only the throttle cable supplied with the machine.

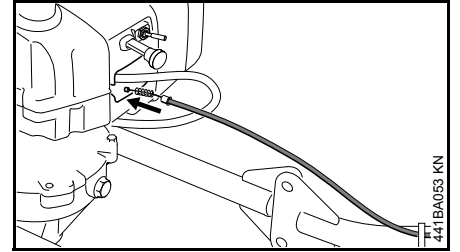

- Push the throttle cable – small nipple first – through the opening.

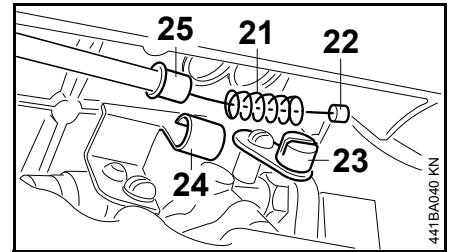

- Slip the spring (21) over the small nipple (22) on the throttle cable.
- Attach nipple (22) to the lever (23) on the carburetor.
- Push spring (21) against the lever (23) – fit the throttle cable in the retainer (24) and push the throttle cable's end sleeve (25) into the retainer (24) as far as stop.

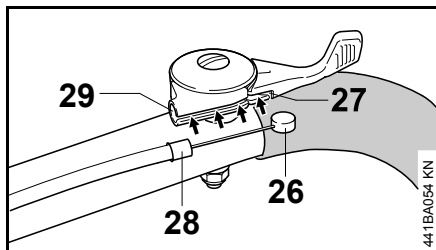

- Fit throttle cable nipple (26) in the recess (27) on the underside of the throttle lever.
- Position the throttle cable in the guide (arrows).
- Push the end sleeve (28) into its seat (29) in the throttle lever.

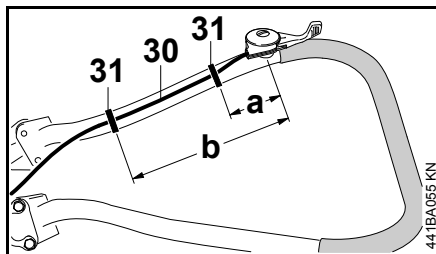

- Secure the throttle cable (30) to the handlebar with two cable ties, $a = 70$ mm and $b = 320$ mm – the throttle cable should be on the inside of the handlebar.

Checking Operation of Throttle Lever

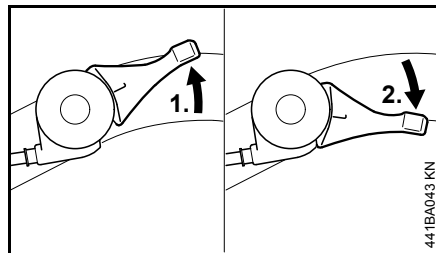

1. Operate the throttle lever.
2. Release the throttle lever – it must return automatically to idle position.

Mounting Stop Switch on Handlebar

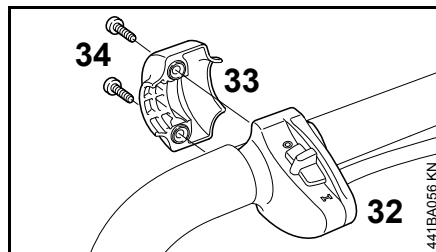

- Position stop switch (32) against handlebar.
- Fit the clamp (33).
- Insert the screws (34) and tighten them down firmly.

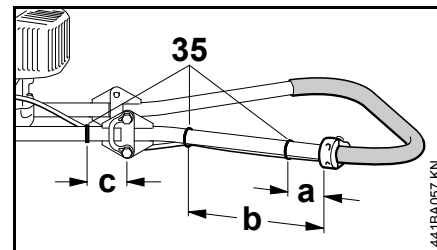

- Secure wiring harness to the handlebar with three cable ties (35), $a = 60$ mm, $b = 300$ mm and $c = 60$ mm – wiring harness should be on inside of the handlebar.

Preparing Machine for Transportation

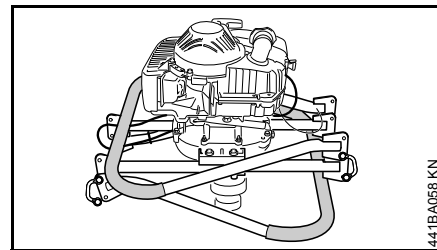

- Loosen and remove the lower hex head screws on the hinge plates at the throttle cable side and the upper hex head screws on the hinge plates at the other side.
- Loosen the other hex head screws on the hinge plates (about 1/2 turn).
- Fold the handlebar at the throttle cable side upwards, and the handlebar at the other side downwards – take care not to kink the throttle cable.

All hex head screws on the hinges must be tightened down firmly after unfolding the handlebars.

Fuel

Your engine requires a mixture of gasoline and engine oil.

WARNING

For health reasons, avoid direct skin contact with gasoline and avoid inhaling gasoline vapor.

STIHL MotoMix

STIHL recommends the use of STIHL MotoMix. This ready-to-use fuel mix contains no benzol or lead, has a high octane rating and ensures that you always use the right mix ratio.

STIHL MotoMix uses STIHL HP Ultra two-stroke engine oil for an extra long engine life.

MotoMix is not available in all markets.

Mixing Fuel



NOTICE

Unsuitable fuels or lubricants or mix ratios other than those specified may result in serious damage to the engine. Poor quality gasoline or engine oil may damage the engine, sealing rings, hoses and the fuel tank.

Gasoline

Use only high-quality **brand-name** gasoline with a minimum octane rating of 90 – leaded or unleaded.

If your machine is equipped with a catalytic converter, you must use unleaded gasoline.



NOTICE

A few tankfuls of leaded gasoline will greatly reduce the efficiency of the catalytic converter.

Gasoline with an ethanol content of more than 10% can cause running problems in engines with a manually adjustable carburetor and should not be used in such engines.

Engines equipped with M-Tronic deliver full power when run on gasoline with an ethanol content of up to 25% (E25).

Engine oil

Use only high-quality two-stroke engine oil – preferably **STIHL HP, HP Super or HP Ultra, which are specially formulated for use in STIHL engines. HP Ultra guarantees high performance and a long engine life.**

These engine oils are not available in all markets.

Use only **STIHL 50:1 two-stroke engine oil** for the fuel mix in models with a catalytic converter.

Mix Ratio

STIHL 50:1 two-stroke engine oil: 50 parts gasoline to 1 part oil

Examples

Gasoline Liters	STIHL engine oil 50:1	
	Liters	(ml)
1	0.02	(20)
5	0.10	(100)
10	0.20	(200)
15	0.30	(300)
20	0.40	(400)
25	0.50	(500)

- Use a canister approved for storing fuel. Pour oil into canister first, then add gasoline and mix thoroughly.

Storing Fuel

Store fuel only in approved safety-type fuel canisters in a dry, cool and safe location protected from light and the sun.

Fuel mix ages – only mix sufficient fuel for a few weeks work. Do not store fuel mix for longer than 30 days. Exposure to light, the sun, low or high temperatures can quickly make the fuel mix unusable.

STIHL MotoMix may be stored for up to 2 years without any problems.

- Thoroughly shake the mixture in the canister before fueling your machine.



WARNING

Pressure may build up in the canister – open it carefully.

- Clean the fuel tank and canister from time to time.

Dispose of remaining fuel and cleaning fluid properly in accordance with local regulations and environmental requirements.

Fueling



Preparations

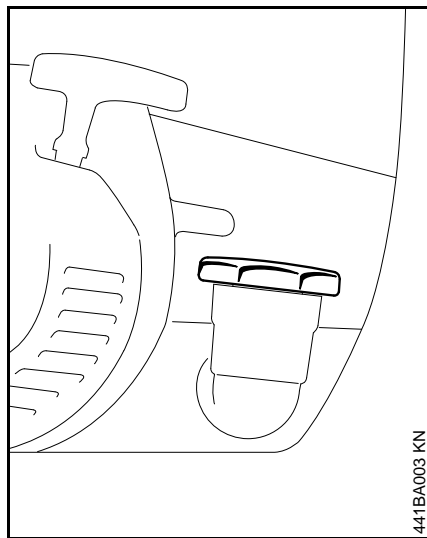

- Before fueling, clean the filler cap and the area around it to ensure that no dirt falls into the tank.
- Position the machine so that the filler cap is facing up.
- Open the filler cap.

Fill up with fuel.

Take care not to spill fuel while fueling and do not overfill the tank. STIHL recommends you use the STIHL filler nozzle for fuel (special accessory).

WARNING

After fueling, tighten down the filler cap as securely as possible by hand.

Change the fuel pickup body every year

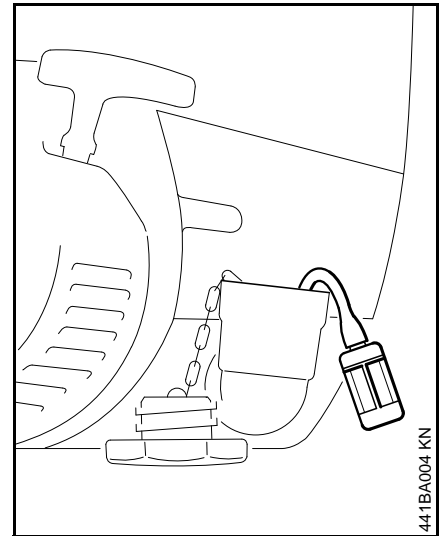

- Drain the fuel tank.
- Use a hook to pull the fuel pickup body out of the tank and take it off the hose.
- Push the new fuel pickup body into the hose.
- Place the fuel pickup body in the tank.

Starting / Stopping the Engine

Starting the Engine

WARNING

To reduce the risk of serious accidents and injury never start the engine with the auger in the spindle.

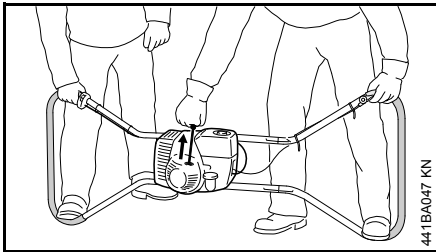

- Place the machine on the ground so that it rests on the handle frame with the throttle lever at the top. Both operators must hold the handlebar steady and secure it by putting one foot through each end of the handlebar and pressing down.
- Observe safety precautions – see chapter on "Safety Precautions and Working Techniques".

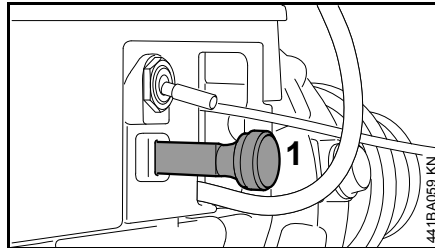

- Pull the choke knob (1) out if the engine is cold. Push the choke knob (1) in if the engine is warm (also use this position if engine has been running but is still cold).

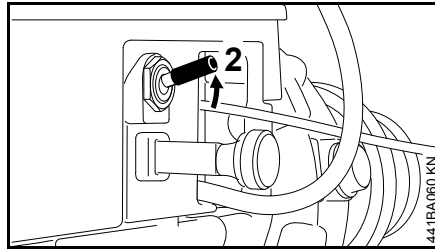

- Move the stop switch (2) away from "STOP".

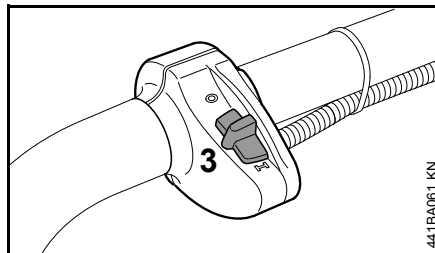

- Move the stop switch (3) to I.

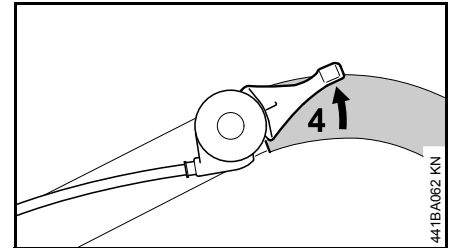

- Turn the throttle lever (4) with your left hand until it is in line with the handlebar (starting throttle position).

Cranking

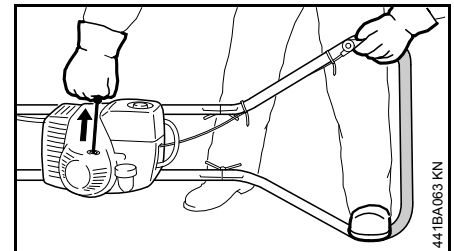

- Pull the starter grip slowly with your right hand until you feel it engage and then give it a brisk strong pull. Do not pull out the starter rope to full length – it might otherwise break.
- Do not let the starter grip snap back. Guide it slowly back into the housing so that the starter rope can rewind properly.

If the engine is new, pull the starter rope several times to prime the fuel system.

When the engine begins to fire:

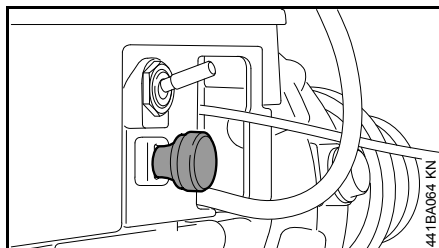

- Push in the choke knob and continue cranking.

As soon as the engine runs

- Release the throttle lever immediately – the engine will settle down to idling speed.

Make sure the carburetor is correctly adjusted. The drilling spiggle must not rotate when the engine is idling.

Your machine is now ready for operation.

Shut off the engine

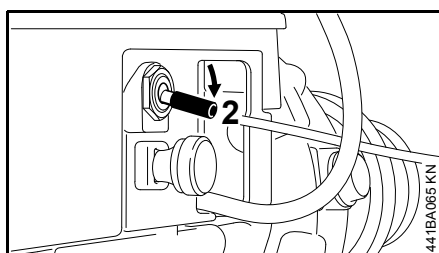

- Move the stop switch (2) on the powerhead to **STOP**.

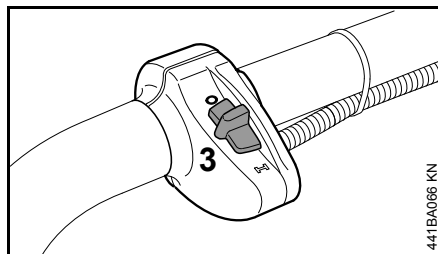

- Move the stop switch (3) on the handlebar to **0**.

Other Hints on Starting

At very low outside temperatures

- Warm up the engine.

If the engine does not start

If you did not push in the choke knob quickly enough after the engine began to fire, the combustion chamber is flooded.

- Move the stop switch on the powerhead to **STOP**.
- Move the stop switch on the handlebar to **0**.
- Remove the spark plug – see "Spark Plug".
- Dry the spark plug.
- Crank the engine several times with the starter to clear the combustion chamber.
- Refit the spark plug – see "Spark Plug".
- Move the stop switch on the powerhead away from **STOP**.
- Move the stop switch on the handlebar to **I**.

- Push in the choke knob – even if the engine is cold.
- Now start the engine.

If fuel tank has been run completely dry and then refueled

- Pull the starter rope several times to prime the fuel system.

Fitting the Auger

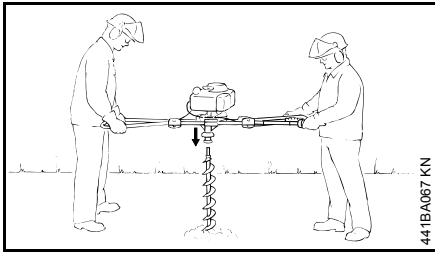

- Hold the auger bit vertically and drop it from a height of about 50 cm so that its tip pierces the ground and stays upright.
- With the engine running at idle speed, position the powerhead on the upright auger bit. Make sure the end of the auger properly engages the drilling spindle's coupling.

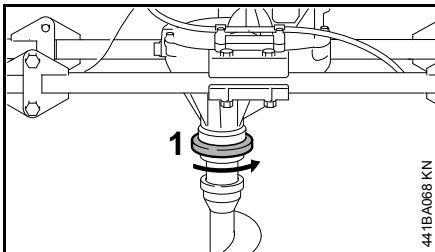

- Lock the auger in the drilling spindle by rotating the clamp ring (1) one quarter turn counterclockwise.

Operating Instructions

During break-in period

A factory-new machine should not be run at high revs (full throttle off load) for the first three tank fillings. This avoids unnecessary high loads during the break-in period. As all moving parts have to bed in during the break-in period, the frictional resistances in the engine are greater during this period. The engine develops its maximum power after about 5 to 15 tank fillings.

During Operation

After a long period of full throttle operation, allow the engine to run for a short while at idle speed so that engine heat can be dissipated by the flow of cooling air. This protects engine-mounted components (ignition, carburetor) from thermal overload.

After Finishing Work

Storing for a short period: Wait for the engine to cool down. To avoid condensation, fill the fuel tank and keep the machine in a dry place, well away from sources of ignition, until you need it again. For longer out-of-service periods – see "Storing the Machine".

Working with shaft extension (special accessory)

Do not fit the shaft extension until the full length of the auger is in the hole.

WARNING

Starting a hole with the shaft extension fitted increases the risk of personal injury because the unit is then at chest height and cannot be controlled properly. For the same reason the shaft extension must be removed before the auger is pulled out of the hole.

Inspection by a specialist

If the machine is used commercially, it must be inspected at least once a year by a specialist.

Specialists are persons with the technical training and experience necessary to assess the safe working condition of the earth auger.

Releasing a Trapped Auger

If the auger jams in the hole – shut off the engine immediately.

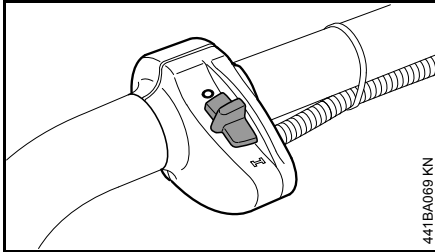

- Move the stop switch on the handlebar to **0**.

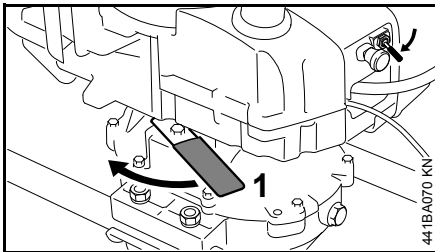

- Move the stop switch on the powerhead to **STOP**.
- Swing the interlock lever (1) to the left to block the gearbox.
- Rotate the whole machine counterclockwise to unwind the auger from the ground.

The interlock lever is designed to disengage automatically if the maximum unwinding torque is exceeded. This reduces the risk of damaging the drilling gear.

Cleaning the Air Filter

If there is a noticeable loss of engine power

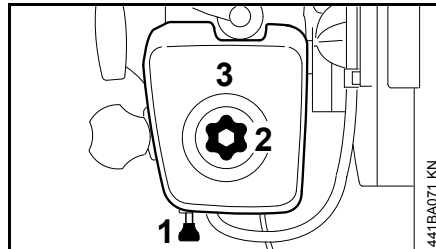

- Pull out the choke knob (1).
- Loosen the twist lock (2) on the filter cover.
- Remove the filter cover (3).
- Clean away loose dirt from around the filter and inside the filter cover.

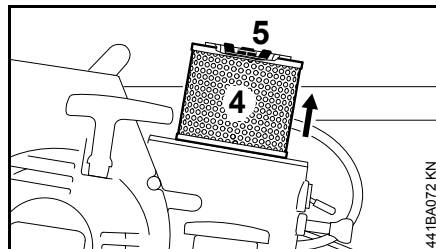

- Inspect the main filter (4).
- If it is dirty or damaged:
- Unscrew the end cover (5) with wingnut.
 - Remove and replace the main filter.

Always install a new auxiliary filter together with the new main filter.

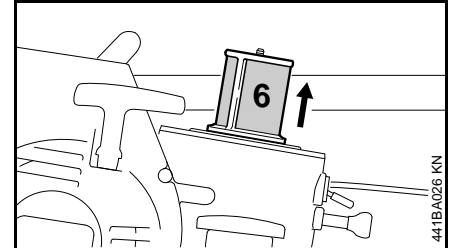

- Inspect the auxiliary filter (6) – if it is dirty, knock it out on the palm of your hand – if it is damaged, install a new one.

When removing the auxiliary filter take care to ensure that no dirt falls into the intake.

- Clean the filter box – reassemble all filter components.
- Refit the filter cover.
- Tighten down the screw.
- Push in the choke knob.

Adjusting the Carburetor

General Information

This setting provides an optimum fuel-air mixture under most operating conditions.

Readjust idle

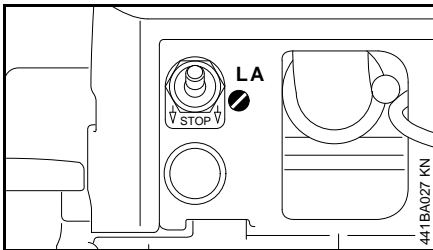

Engine stops while idling

- Turn the idle speed screw (LA) clockwise until the drilling spindle begins to rotate – then back it off 1/2 a turn.

Drilling spindle rotates when engine is idling

- Turn the idle speed screw (LA) counterclockwise until the drilling spindle stops rotating – then turn it another 1/2 turn in the same direction.

Spark Plug

- If the engine is down on power, difficult to start or runs poorly at idle speed, first check the spark plug.
- Fit a new spark plug after about 100 operating hours – or sooner if the electrodes are badly eroded. Install only suppressed spark plugs of the type approved by STIHL – see "Specifications".

Removing the Spark Plug

- Move the stop switch on the powerhead to **STOP**.
- Move the stop switch on the handlebar to **0**.
- Pull boot off the spark plug.
- Unscrew the spark plug.

Checking the spark plug

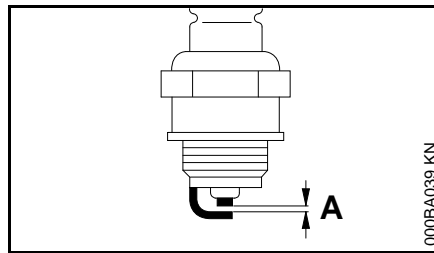

- Clean dirty spark plug.
- Check electrode gap (A) and readjust if necessary – see "Specifications".
- Rectify the problems which have caused fouling of the spark plug.

Possible causes are:

- Too much oil in fuel mix.
- Dirty air filter.
- Unfavorable running conditions.

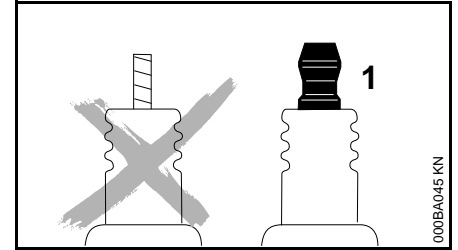

! WARNING

If the spark plug comes with a detachable adapter nut (1), screw the adapter onto the thread and tighten it down **firmly** to reduce the **risk of arcing and fire**.

Installing the Spark Plug

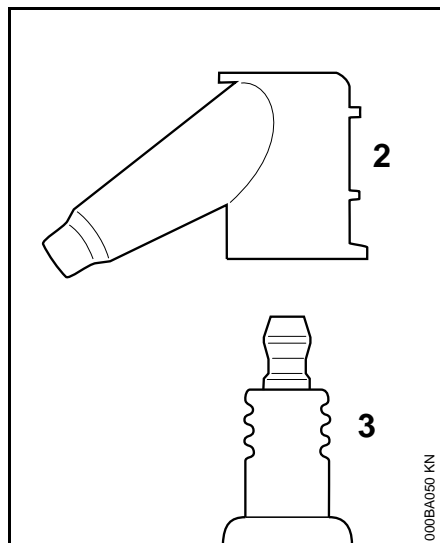

- Screw the spark plug (3) into the cylinder and fit the boot (2) (press it down firmly).

Engine Running Behavior

If engine running behavior is unsatisfactory even though the air filter is clean and the carburetor is properly adjusted, the cause may be the muffler.

Have the muffler checked for contamination (carbonization) by your servicing dealer.

STIHL recommends that you have servicing and repair work carried out exclusively by an authorized STIHL servicing dealer.

Lubricating the Gearbox

Use a mildly alloyed gear oil (see "Special Accessories") for lubrication of the gearbox.

Checking Oil Level / Refilling

- Check the oil level regularly – once a week in normal operating conditions.
- Remove the auger.

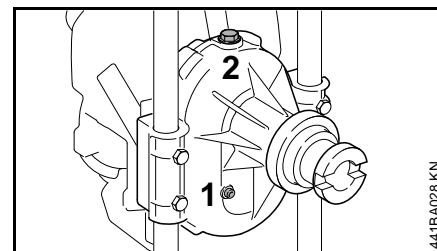

- Position the gearbox vertically so that the drilling spindle is horizontal and the throttle trigger is at the top.
- Take out the inspection plug (1).
- Check the oil level – it must come up to the bottom edge of the hole.

If the oil level does not reach the bottom edge of the hole, top up with oil.

- Take out the filler plug (2).
- Fill up with oil as far as the bottom edge of the inspection hole.
- Refit the inspection and filler plugs with sealing rings and tighten them down firmly.

Changing Gearbox Oil

Drain the oil while it is at normal operating temperature.

- Position the gearbox so that the drilling spindle is vertical and points downwards.
- Take out the inspection plug (1).
- Collect the gearbox oil in a suitable container.
- Dispose of old oil properly in accordance with local regulations.
- Fill the gearbox with fresh oil as described under "Checking Oil Level / Refilling".

Rewind Starter

To help prolong the wear life of the starter rope, observe the following points:

- Pull the starter rope only in the direction specified.
- Do not pull the rope over the edge of the guide bushing.
- Do not pull out the rope more than specified.
- Do not allow the starter grip to snap back, guide it back into the housing slowly – see chapter on "Starting / Stopping the Engine."

Have a damaged starter rope replaced by your dealer before it breaks completely. STIHL recommends that you have servicing and repair work carried out exclusively by an authorized STIHL servicing dealer.

Storing the Machine

For periods of 3 months or longer

- Remove the drilling tool.
- Drain and clean the fuel tank in a well ventilated area.
- Dispose of fuel properly in accordance with local environmental requirements.
- Run the engine until the carburetor is dry – this helps prevent the carburetor diaphragms sticking together.
- Thoroughly clean the machine – pay special attention to the cylinder fins and air filter.
- Store the machine in a dry, high or locked location, out of the reach of children and other unauthorized persons.

Maintenance and Care

The following intervals apply to normal operating conditions only. If your daily working time is longer or operating conditions are difficult (very dusty work area, etc.), shorten the specified intervals accordingly.		before starting work	after finishing work or daily	after each refueling stop	weekly	monthly	every 12 months	if problem	if damaged	if required
Complete machine	Visual inspection (condition, leaks)	X		X						
	Clean		X							
Throttle lever	Check operation	X		X						
Handle hoses, throttle lever (coating)	Visual inspection	X								
Interlock lever	Check operation	X		X						
Air filter (auxiliary filter)	Clean							X		
Air filters (main and auxiliary)	Replace								X	X
Manual fuel pump (if fitted)	Check	X								
	Have repaired by servicing dealer ²⁾								X	
Pickup body in fuel tank	Check							X		
	Replace						X			X
Fuel tank	Clean					X				
Cooling inlets	Clean		X							
Cylinder fins	Clean		X							
Carburetor	Check idle adjustment – drilling spindle must not rotate	X								
	Readjust idle									X
Spark plug	Readjust electrode gap							X		
	Replace after every 100 operating hours									
Spark arresting screen ¹⁾ in muffler	Have checked by dealer ²⁾							X		
	Have cleaned or replaced by servicing dealer ²⁾								X	X
All accessible screws and nuts (not adjusting screws)	Retighten									X

English

The following intervals apply to normal operating conditions only. If your daily working time is longer or operating conditions are difficult (very dusty work area, etc.), shorten the specified intervals accordingly.		before starting work	after finishing work or daily	after each refueling stop	weekly	monthly	every 12 months	if problem	if damaged	if required
Gearbox	Checking oil level				X					X
	Change gearbox oil						X			
Drilling spindle	Clean		X							
Auger	Check	X								
	Replace									X
Safety labels	Replace								X	

1) not in all versions, market-specific

2) STIHL recommends a STIHL servicing dealer.

Minimize Wear and Avoid Damage

Observing the instructions in this manual helps reduce the risk of unnecessary wear and damage to the power tool.

The power tool must be operated, maintained and stored with the due care and attention described in this owner's manual.

The user is responsible for all damage caused by non-observance of the safety precautions, operating and maintenance instructions in this manual. This includes in particular:

- Alterations or modifications to the product not approved by STIHL.
- Using tools or accessories which are neither approved or suitable for the product or are of a poor quality.
- Using the product for purposes for which it was not designed.
- Using the product for sports or competitive events.
- Consequential damage caused by continuing to use the product with defective components.

Maintenance Work

All the operations described in the "Maintenance Chart" must be performed on a regular basis. If these maintenance operations cannot be performed by the owner, they should be performed by a servicing dealer.

STIHL recommends that you have servicing and repair work carried out exclusively by an authorized STIHL

servicing dealer. STIHL dealers are regularly given the opportunity to attend training courses and are supplied with the necessary technical information.

If these maintenance operations are not carried out as specified, the user assumes responsibility for any damage that may occur. Among other parts, this includes:

- Damage to the engine due to neglect or deficient maintenance (e.g. air and fuel filters), incorrect carburetor adjustment or inadequate cleaning of cooling air inlets (intake ports, cylinder fins).
- Corrosion and other consequential damage resulting from improper storage.
- Damage to the machine resulting from the use of poor quality replacement parts.

Parts Subject to Wear and Tear

Some parts of the power tool are subject to normal wear and tear even during regular operation in accordance with instructions and, depending on the type and duration of use, have to be replaced in good time. Among other parts, this includes:

- Clutch
- Augers
- Filters (air, fuel)
- Rewind starter
- Spark plug

Main Parts

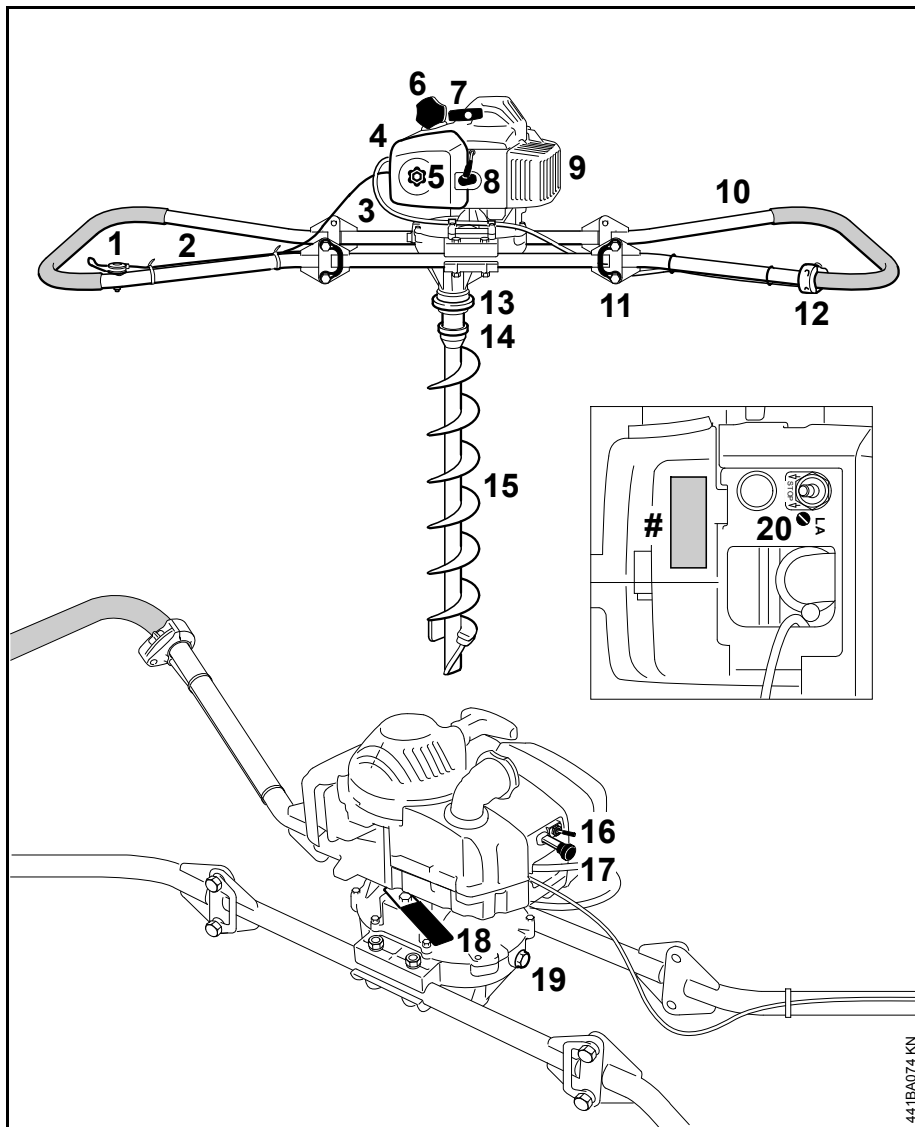

- 1 Throttle lever
- 2 Throttle cable
- 3 Wiring harness
- 4 Filter cover
- 5 Filler plug
- 6 Fuel filler cap
- 7 Starter grip
- 8 Spark plug boot
- 9 Muffler
- 10 Handle frame (foldable)
- 11 Retainer
- 12 Stop switch on handlebar
- 13 Clamp ring
- 14 Drilling spindle
- 15 Auger
- 16 Stop switch on powerhead
- 17 Choke knob
- 18 Interlock lever
- 19 Filler plug
- 20 Idle speed screw (LA)
- # Serial number

441BA074 KN

Specifications

Engine

STIHL single cylinder two-stroke engine

Displacement:	60.3 cm ³
Bore:	49 mm
Stroke:	32 mm
Engine power to ISO 7293:	2.9 kW (3.9 HP) at 8,000 rpm
Idle speed:	2,500 rpm

Ignition System

Electronic magneto ignition

Spark plug (resistor type):	NGK BPMR 7 A, Bosch WSR 6 F
Electrode gap:	0.5 mm

Fuel System

All position diaphragm carburetor with integral fuel pump

Fuel tank capacity:	550 cc (0.55 l)
---------------------	-----------------

Weight

Dry, without auger	28.8 kg
--------------------	---------

Drilling Gear

Three-stage spur gear drive

Gear ratio:	151:1
Maximum spindle speed:	50 rpm
Lubrication:	EP 90 (SAE 90) mildly alloyed gear oil
Oil capacity:	0.5 l

Augers

Earth augers	
Diameter:	90 to 350 mm
Weight:	8.0 to 24.3 kg

Noise and Vibration Data

Noise and vibration data are measured at idling and maximum rated speed in a ratio of 1:4.

For further details on compliance with Vibration Directive 2002/44/EC see www.stihl.com/vib/

Sound pressure level L_{peq} to ISO 11201

99 dB(A)

Sound power level $L_{w\text{eq}}$ to ISO 3744

111 dB(A)

Vibration measurement $a_{hv,eq}$ to ISO 20643

Left handle:	6.8 m/s ²
Right handle:	8.7 m/s ²

The K-factor in accordance with Directive 2006/42/EC is 2.5 dB(A) for the sound pressure level and sound power level; the K-factor in accordance with Directive 2006/42/EC is 2.0 m/s² for the vibration measurement.

REACH

REACH is an EC regulation and stands for the Registration, Evaluation, Authorisation and Restriction of Chemical substances.

For information on compliance with the REACH regulation (EC) No. 1907/2006 see www.stihl.com/reach.

Special Accessories

- 500 mm extension shaft
- 1000 mm extension shaft

Contact your STIHL dealer for more information on these and other special accessories.

Maintenance and Repairs

Users of this machine may only carry out the maintenance and service work described in this user manual. All other repairs must be carried out by a servicing dealer.

STIHL recommends that you have servicing and repair work carried out exclusively by an authorized STIHL servicing dealer. STIHL dealers are regularly given the opportunity to attend training courses and are supplied with the necessary technical information.

When repairing the machine, only use replacement parts which have been approved by STIHL for this power tool or are technically identical. Only use high-quality replacement parts in order to avoid the risk of accidents and damage to the machine.

STIHL recommends the use of original STIHL replacement parts.

Original STIHL parts can be identified by the STIHL part number, the **STIHL** logo and the STIHL parts symbol  (the symbol may appear alone on small parts).

Disposal

Observe all country-specific waste disposal rules and regulations.

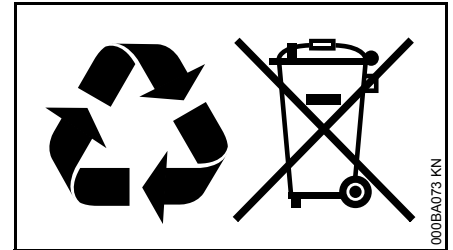

STIHL products must not be thrown in the garbage can. Take the product, accessories and packaging to an approved disposal site for environment-friendly recycling.

Contact your STIHL servicing dealer for the latest information on waste disposal.

EC Declaration of Conformity



ANDREAS STIHL AG & Co. KG
Badstr. 115
D-71336 Waiblingen

confirms that the product described
below

Category: Earth Auger
Make: STIHL
Model: BT 360
Serial identification: 4308
Displacement: 60.3 cm³

conforms to the specifications of
Directives 2006/42/EC and
2004/108/EC and has been developed
and manufactured in compliance with
the following standards:

EN ISO 12100, EN 55012,
EN 61000-6-1

Technical documents deposited at:

ANDREAS STIHL AG & Co. KG
Produktzulassung (Product Licensing)

The year of manufacture and serial
number are applied to the product.

Done at Waiblingen, 01.08.2012

ANDREAS STIHL AG & Co. KG

A handwritten signature in black ink that reads 'Thomas Elsner'.

Thomas Elsner
Director Group Product Management

BT 360

25

0458-441-0121-B

englisch



www.stihl.com



0458-441-0121-B