

INSTRUCTION MANUAL

DENYO

DIESEL GENERATING SETS

DCA-SPI,3 SERIES

220SP ~ 300SP CLASS

 **Denyo Co., Ltd.**

This instruction manual gives a detailed description of the operation, routine inspection, maintenance, and troubleshooting of the generator, and other items required for proper operation. We therefore recommend that all users read this manual carefully before actually operating the generator to ensure proper operation. For detailed operation, disassembly, reassembly and repair of the engine, please refer to the "Engine Instruction Manual" supplied by the engine manufacture.

CONTENTS

1. PRECAUTIONS FOR SAFE OPERATION	-----	1
2. MAJOR SPECIFICATIONS	-----	3
3. PARTS DESIGNATION	-----	5
4. PREPARATION FOR OPERATION	-----	11
5. OPERATION	-----	18
6. PARALLEL OPERATION	-----	21
7. STORAGE	-----	23
8. INSPECTION AND MAINTENANCE	-----	24
9. TROUBLESHOOTING	-----	25
10. GENERATOR CONNECTION DIAGRAM	-----	26
11. ENGINE CONNECTION DIAGRAM	-----	28
12. SAFETY PRECAUTIONS FOR DIESEL GENERATING SETS AND EQUIPMENT	-----	31

1. PRECAUTIONS FOR SAFE OPERATION

This machine is designed with highest consideration to safety. Safest and most efficient operation, however, can be attained by paying attention to the following items.

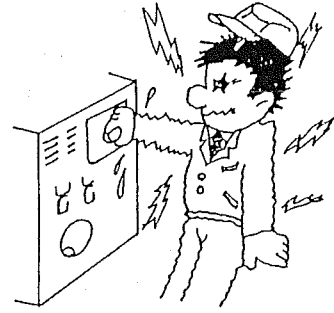

(1) Operate Properly

Operate the machine properly according to the Instruction Manual to ensure safety.

Give proper guidance in operation

In allowing other personnel to use the machine, be sure to give the m proper guidance in its operation and advise them to read the "Instruction Manual" before actually operating it.

(2) Keep Free From Moisture

The operation of the machine in a place exposed to rain, moisture or wetness may cause electrocution. For operation under such conditions, be sure to ground the machine and the load side.

(3) Housekeeping, The First Step

Do not place any unnecessary items around the machine.

When the machine is to be located on an uneven or soft surface, install it horizontally so that it will not tilt during operation.

(4) Clean Carefully And Frequently

The machine must be treated properly as your business partner.

Note that the insulation of the generator may deteriorate depending on the place where it is used. If it is to be used in a place where dust and moisture are excessive, be sure to clean and dry it periodically.

(5) Pay Attention To Sufficient Ventilation

The exhaust gas discharged from the machine contains hazardous substances. When the machine is to be used in such a place as a tunnel, ventilate the place thoroughly during operation. When it is to be operated on the road, take care that the exhaust is away from pedestrians, nearby buildings, etc.

(6) Shut Down Operation Immediately If Any Abnormality Occurs

If the machine is found to operate improperly, or produce any abnormal odor, noise, or vibration, immediately shut down the operation for troubleshooting to correct the abnormality.

(7) Maintain Electrical Instrument Cables Properly

Damaged cables of the electrical instruments are very dangerous, causing electrocution and leakage. Therefore, if such a cable is found, immediately repair or replace it.

(8) Avoid Overloading

The generator is provided with a breaker for overload protection, which is actuated when it is overloaded. When the breaker has been actuated, reduce the load before restarting the machine.



(9) Never Touch The Output Terminal

Never touch the output terminal during the operation. Be sure to shut down the operation before touching the terminal for wiring, etc.

(10) Pay Attention To Storage And Transportation During Inclement Weather

The machine is designed for dripproofing, but not for rainproofing. When it is to be stored or transported on an inclement day, take care to cover it.

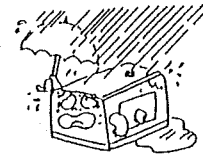

(11) Wash The Machine Carefully

Wash the machine taking care that the control panel and the inlet and outlet ports are not exposed to water to prevent possible failure of the internal instruments.

(12) Take Precautions Against Fire

Handle fuel, oils and antifreeze (undiluted) with care because they are dangerous materials with high flammability. Do not bring any naked light such as lit tobacco or a burning match close to them. In addition, do not install and store the machine in a place near where fire is used.

(13) Connect Securely

Damaged cables and loosened screws result in machine failure and electrocution. Therefore, immediately repair such cables and tighten such screws securely, if any.

(14) Perform Inspection And Maintenance Work

Perfectly
Keep the machine clean and its inside free from dust and moisture. In addition, perform its inspection and maintenance perfectly in accordance with the "Instruction Manual".

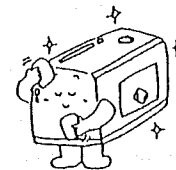

2. MAJOR SPECIFICATION

A C G E N E R A T O R	MODEL	DCA-220SPM II	DCA-220SPK II, 3	DCA-300SPK II, 3
	MODEL	DF-2400M	DF-2400K	DF-3300K
	RATED OUTPUT	200/220 kVA		270/300
		160/176 kW		216/240
	RATED VOLTAGE	200/220 V		
		400/440 V		
	RATED CURRENT	577/577 A		779/787
		289/289 A		390/394
	FREQUENCY	50 / 60 Hz		
	POWER FACTOR	0.8 (lagging)		
	NO. OF PHASES	Three-phase (four wire)		
	EXCITATION	Brushless type (with automatic voltage regulator)		
	NO. OF POLES	4		
	SPEED	1500 / 1800 min ⁻¹		
INSULATION	TYPE F			
AUX. POWER	100 / 110 V 1.5 kVA × 2			
E N G I N E	MANUFACTURE	MITSUBISHI	KOMATSU	KOMATSU
	MODEL	6D24-TCE2	S6D125E-2-A	SA6D125E-2-A
	TYPE	4 cycle watercooled diesel engine direct injection with turbocharger		
	(AC:aftercooler)	AC		AC
	RATED OUTPUT (1500/1800min ⁻¹)	181/199 kW	178/204	232/257
		246/270 PS	242/277	316/350
	NO. OF CYLINDERS	6-	6-	6-
	BORE × STROKE (mm)	130 × 150	125 × 150	125 × 150
	TOTAL DISPLACEMENT	11.945 L	11.04	11.04
	BATTERY (DOMESTIC STANDERD)	12V - 150Ah × 2		
	FUEL	DIESEL FUEL ASTM No.2 or equivalent		
	FUEL TANK CAP.	380 L	380	490
	FUEL CONSUMPTION (APPROX. L / h)	42/47	41/47	57/67
	LUBRICATING OIL (CAPACITY APPROX.)	37 L	40	62
COOLANT QUANTITY (OVERALL)	45 L	34	35	
S E T	LENGTH OVERALL	3700 mm	3650	3750
	WIDTH OVERALL	1300 mm	1300	1400
	HEIGHT	1750 mm	1750	1800
	DRY WEIGHT	3670 kg	3670	4160

The above specifications and set dimensions are subject to change.

2 - 1 . AC GENERATOR SPECIFICATIONS (FOR CUSTOM VOLTAGE)

DCA-220SP		5 0 H z			6 0 H z	
		RATED OUTPUT	kVA	200	200	200
	kW	160	160	160	176	176
RATED VOLTAGE (V)		190/380	415	220/440	200/400	240/480
RATED CURRENT (A)		608/304	278	525/262	635/318	529/265
AUX. POWER VOLTAGE (V)		100	100	110	110	120

DCA-300SP		5 0 H z			6 0 H z	
		RATED OUTPUT	kVA	270	270	270
	kW	216	216	216	240	240
RATED VOLTAGE (V)		190/380	415	220/440	200/400	240/480
RATED CURRENT (A)		820/410	376	709/354	866/433	722/361
AUX. POWER VOLTAGE (V)		100	100	110	110	120

3. PARTS DESIGNATION

3-1. Description of Engine Control Devices

(1) Starter Switch

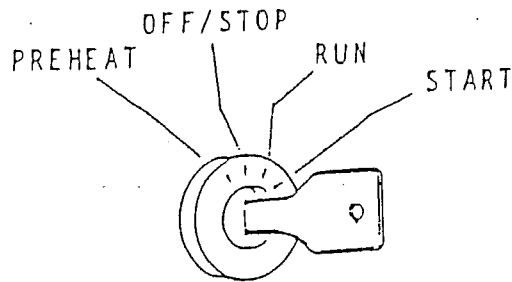

① OFF/STOP

Keep the switch at this position except during operation. This position allows the key to be inserted into and removed from the switch.

② RUN

Keep the switch standing at this position during operation.

③ START

Turn the switch to this position for startup. When the key is released after startup, it automatically returns to "RUN" position.

④ PREHEAT

For startup at low air temperature, set the switch at this position until the PREHEAT lamp becomes red-heated just before turning the key to "START" position.

NOTE: It should be noted that 220SPMII is designed so that the PREHEAT lamp lights up when the switch is held at the "RUN" position. When the lamp goes off, immediately turn the key to the "START" position. Also note that the preheating time automatically changes according to the water temperature of the engine.

(2) Tachometer

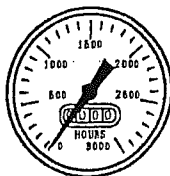

The tachometer indicates engine revolutions per minute. Set the engine speed so that the meter indicates 1500min^{-1} at 50Hz and 1800min^{-1} at 60Hz. The tachometer has a built-in integrating hour meter.

The integrating hour meter has been set for use at 1500min^{-1} . Accordingly, when the meter is used at 1800min^{-1} , it indicates an integrated hour value approximately 20% more than the actual operation time.

(3) Cooling Water Temperature Gauge

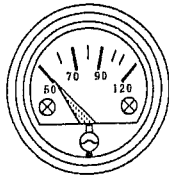

If machine is in normal operation, the indicator should be between 75-95°C. If it indicates temperature above this range, turn off the load and adjust the speed control handle for cold operation (at approximately 700~800min⁻¹) to reduce the cooling water temperature.

(4) Lubricating Oil Pressure Gauge

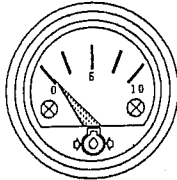

If the machine is in normal operation, the pressure gauge indicates 2.5~6×100kPa (2.5~6 kg/cm²).

When the engine is cold, the pressure may rise above this range just after startup. In such cases, perform warming-up until the normal pressure is attained.

(5) Fuel level Gauge

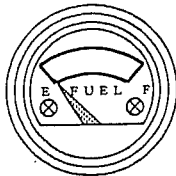

Indicates the fuel level in the fuel tank.

(6) Lubricating Oil Temperature Gauge (300SPKII, 300SPK3)

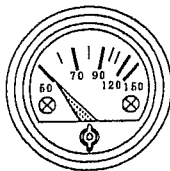

Indicates the oil temperature of the engine oil. The temperature of 100 °C or less is recommended.

(7) Charging Ampere Meter

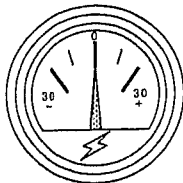

If the machine is in normal operation, the meter points to 0 or + range values (indicating its charged state).

(8) Preheat Lamp (220SPMII)



If water temperature is under 0 centigrade, please turn the Starter Switch to "Run". If so, it will automatically preheat with the Preheat Indicator Lamp on. It will preheat to the maximum of 20 seconds and when finished, the lamp will turn off.

(9) Preheat Lamp (except 220SPMII)

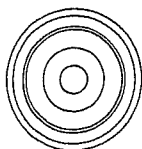

This lamp, when the key switch is turned to "PREHEAT" position, goes red-heated in about 30 seconds, indicating that the machine has been preheated.

(10) Speed Control Handle (Throttle handle)

Turn the handle toward the "HIGH" side to increase the speed and toward the "LOW" side to decrease it.

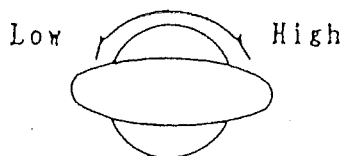

(11) Battery Switch

During operation, never turn the switch to "OFF" position, keeping it at "on". If the engine is shut down, be sure to place the switch in "OFF" position.

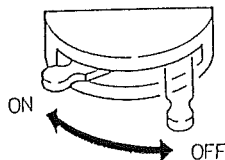

(12) Speed Changeover Switch

① AUTO.IDLING

When the engine is started with the "SPEED" changeover switch set at this position, the engine idles for about 20 seconds and then automatically changes over to high-speed operation. When the "STARTER" switch is turned off, the engine stops immediately. When starting the engine, set the switch in this position.

始動・START
自動アイドリング
AUTO. IDLING

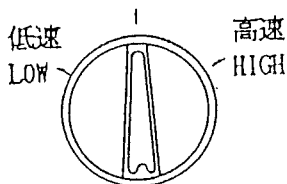

② LOW

When the switch is turned to this position, the engine continues to idle.

③ HIGH

Turning the switch to this position releases the "automatic idling" function, allowing the engine to be run at the speed set by the throttle handle.

(13) Running Caution Lamp

This lamp goes on during low-speed operation.

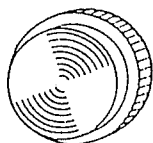

(14) Emergency Stop Button

This is a pushbutton to stop the engine urgently on emergency case. Do not push the button without emergency case.

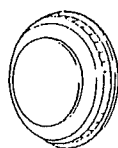

(15) Warning Lamp Unit

This monitor indicates the following failures, if any.

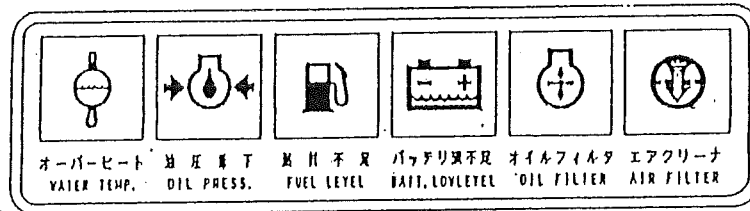

① Overheat

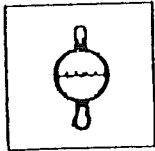

This lamp goes on when the cooling water temperature rises abnormally. If the lamp goes on during operation, the emergency stop device immediately operates to shut down the engine automatically.

② Oil Pressure Failure

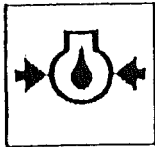

If the machine is in normal operation, this lamp stays off. When the starter switch is turned to "RUN" position to start the engine, the lamp goes on, and when the oil pressure rises after startup, it goes off. If this lamp goes on during operation, the emergency stop device immediately operates to shutdown the engine automatically. After the engine stops, the lamp stays on unless the key switch is turned to "OFF" position.

③ Fuel Level Failure



When fuel is running low, this lamp goes on, and the tank should be filled.

④ Battery Fluid Level Failure

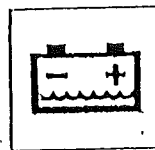

When battery fluid runs low, this lamp goes on, and distilled water should be supplied to the battery.

⑤ Oil filter Blinding

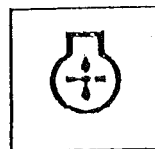

When the engine oil filter is blinded, this lamp goes on. As filter blinding may cause engine burning, when the lamp is lit, replace the filter. Also replace the engine oil concurrently with the filter replacement.

⑥ Air filter Blinding



When the air element is blinded, this lamp goes on. Indicating that the element should be immediately cleaned or replaced. Setting the starter switch at the "STOP" position causes the lamp indication to be automatically reset.

3-2. Description of Generator Control Devices

(1) Frequency Meter

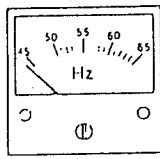

This meter indicates the power frequency. Make sure that the meter pointer stands at 50 or 60Hz during operation.

(2) AC Ammeter

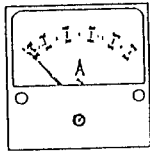

The ammeter indicates the value of current flowing in the load connected. Make sure that the current value is below that rated.

Use the ammeter change-over switch to check each phase for current value.

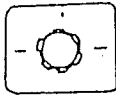

ammeter change-over switch

(3) AC Voltmeter

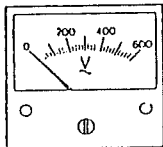

AC voltmeter

The voltmeter indicates the output voltage. Make sure that the voltmeter pointer stands at the rated voltage.

Use the voltmeter change-over switch to check each phase for voltage value.

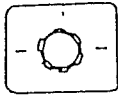

voltmeter change-over switch

(4) Voltage Regulator

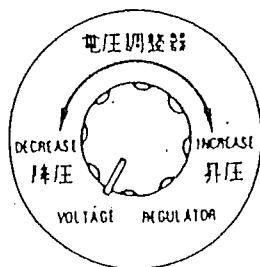

This regulator is used to control the output voltage. Turn the regulator clockwise to increase the voltage and counter-clockwise to decrease it. Adjust the voltage to the rated voltage with this regulator.

(5) Breaker



This breaker serves both as the main switch for power generated from the generator to the load connected to the output terminal, and as the protector of the generator when a short or overload occurs in the load side. Do not use this breaker to turn the load ON or OFF.

(6) Overcurrent Relay

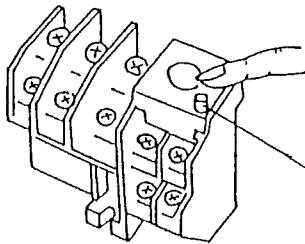

If the actuation of the overcurrent relay causes the breaker not to be turned on, open the control panel and press the reset button as shown in the following drawing.

Reset button

4. PREPARATION FOR OPERATION

4-1. Precautions In Installation

Install the machine horizontally on solid ground.

In addition, when the machine is to be installed in a place where dust and salt are excessive, pay close attention to its maintenance and care to prevent radiator clogging and failure, and electrical-part insulation failure possibly caused by operation under such circumstances.

(1) Precautions In Outdoor Installation

When the machine is to be installed outdoors such as on the road, pay attention to the wind direction and the exhaust port position so that the exhaust gas is blown away from pedestrians and nearby buildings.

(2) Precautions In Indoor Installation

- ① Leave enough space for easy operation and control on the control-panel side (at least 1 m)
- ② Leave enough space for engine inspection, lubrication, connection of cable to the load, fuel supply and other operations both on the right and left sides viewed from the control panel (at least 1 m).
- ③ Install an exhaust pipe so that exhaust gas is discharged through it to an open area.
- ④ Leave enough space for exhaust of warm air discharged through the radiator, supply of water to the radiator, and arrangement of the exhaust pipe above the machine.
- ⑤ Note that the connection of the generator to indoor wiring not only infringes the law, but also may cause electrocution or generator failure.
- ⑥ Note that the machine can be installed directly on a foundation such as concrete.
- ⑦ Install the machine in such a place as can be thoroughly ventilated to prevent a considerable rise in the indoor temperature, which has an adverse effect on the engine generator.

4-2. Check Before Startup

Be sure to check the machine especially for the following points before startup to minimize machine failure.

(1) Check Oil

* Be sure to check the oil level before startup every day.

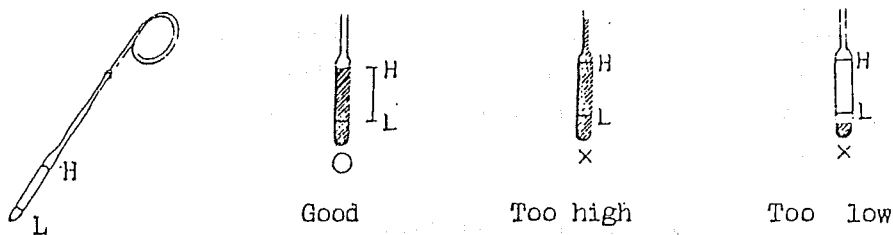

Note : Some engine manufactures provide a level gauge with such H/L marks on both sides, which allows the oil level to be checked during idling. When using such a level gauge, carefully check which of the two H/L marks is used at downtime or during idling.

- * Check engine oil with an oil level gauge to see that the oil level is in between marks H and L of the level gauge, and replenish or replace it if necessary.
- * For oil replenishment, supply a given amount of oil from the oiling port provided on the engine.

[220SPM II, 220SPK II, 220SPK3]

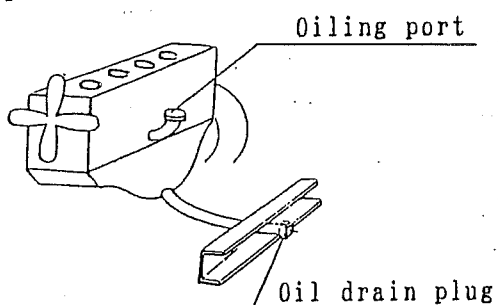

For oil replacement, remove the oil drain plug provided on the machine base to drain the oil. After the oil draining is complete, tighten the oil drain plug securely.

[300SPK II, 300SPK3]

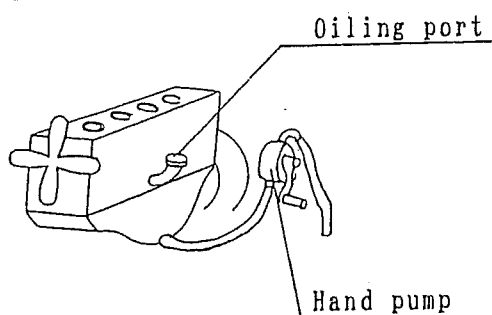

For oil replacement, discharge it by manually turning the lever of the hand pump provided near the engine, and placing its hose outside.

- * After a specified amount of oil engine is supplied, run the engine for several minutes and then stop it to check again to see that the oil level stands in between marks H and L of a level gauge.

Notes : For specified quantity of lubricating oil, refer to the Specifications Table.

(2) Check Cooling Water

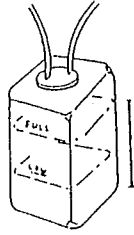

Put water
to "FULL"

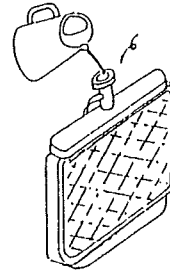

In checking or supplying cooling water, make sure that the engine is cold. For cooling water in winter, refer to the "Engine Instruction Manual".

Use tap water as cooling water and put it up to the root of the filling port. Some machines are provided with a reserve tank. Put tap water in it up to the "FULL" mark.

In setting the radiator cap after the cooling water check or supply, take care to turn it clockwise to full position so that the radiator can be used with its inside kept in a pressurized state. Insecurely-tightened radiator cap may result in serious engine trouble.

Notes : For specified quantity of cooling water, refer to the Specifications Table.

(3) Check Fan Belt

Check the belt for tension and elongation. Adjust them if necessary. If any abnormality is found on the belt, replace it. Perform the adjustment and replacement as directed in "Engine Instruction Manual".

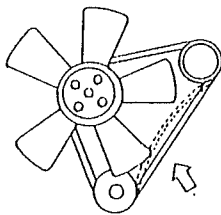

The belt tension is considered to be proper if the flexing level is within 10-15 mm when the arrow-indicated portion (belt center) is pressed with the thumb (approximately 6kg).

(4) Check Fuel

Be sure to check the fuel level before startup to prevent fuel shortage during operation. Occasionally remove sediment and contaminated water collected in the bottom of the fuel tank by loosening its drain plug.

FUEL DRAIN PLUG

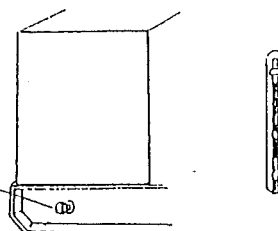

(5) Check Generator Case Grounding

When the generator is installed in a moist place, or on highly conductive material such as iron plates or steel work, be sure to connect the grounding wire terminal provided near the output terminal block and bury the wire 50 cm or deeper in the ground securely.

Do not directly ground terminal "0".

Recommended grounding wire sectional area: 5.5 mm or larger

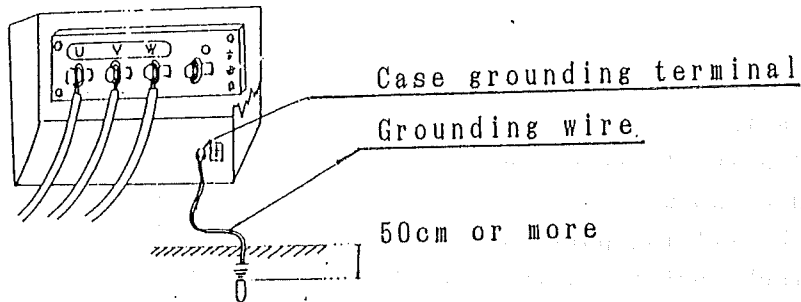

(6) Check For Water And Oil Leakage

Check the engine periphery for water and oil leakage.

If such leakage is found, identify the leak spot and repair it.

(7) Check Bolts And Nuts For Looseness

Check bolts and nuts, especially on the air cleaner, muffler and turbo-charger mounting portion, for looseness and tighten them if necessary.

(8) Check Electrical Wiring For Disconnection, Short And Terminal Looseness.

4-3. Load Connection

(1) Method For Selecting Output Voltage

Select voltage according to the voltage of the load to be used.

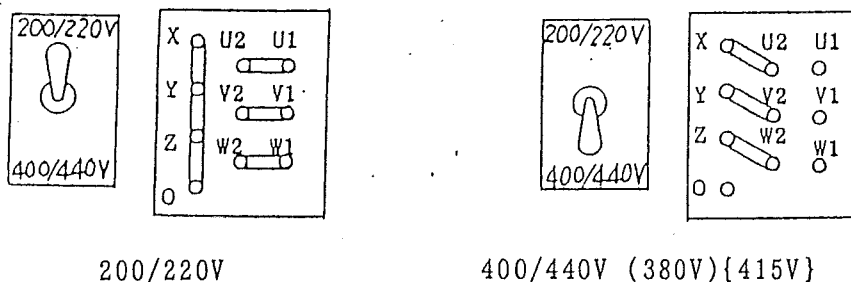

* Method For Selecting Output Voltage

The output voltage of 200/220V or 400/440V, (380V), {415V} can be selected with the voltage changeover plates.

These generators are shipped from the plant with their output voltage set at 200/220V unless otherwise specified.

Change over to the desired output voltage according to the following procedure, if necessary.

- ① The voltage changeover panel is located on the center of the control box.
Open the control panel to remove the set screw.
- ② Change over to the desired output voltage by setting the changeover plates and the changeover switch on its side as shown in the above drawing.
Note that insecure tightening of the locking bolts results in burning.
- ③ In changing the output voltage over to 400/440, take care not to lose superfluous changeover plates by, for example, setting them together with the actually used ones.

(2) Three-phase Output

In connecting a load, tighten locking bolts securely with a spanner, etc. to prevent burning.

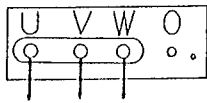

Use U/V/W for three-phase load
200/220V or 400/440V
(380V)
{415V}

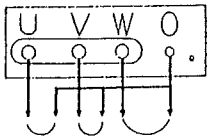

Use 0/U, 0/V, 0/W for single-phase load
115/127V or 231/254V
(220V)
{240V}

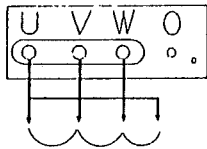

Use U/V, V/W, W/U for single-phase load
200/220V or 400/440V
(380V)
{415V}

☆ Precautions In Load Connection

- ① Be sure to provide a switch for turning the load ON and OFF between the output terminal block and the load.
Note that the use of the generator breaker for turning the load ON and OFF may result in breaker failure.
- ② In connecting the load, be sure to stop the engine and turn OFF the control-panel breakers before load connection.

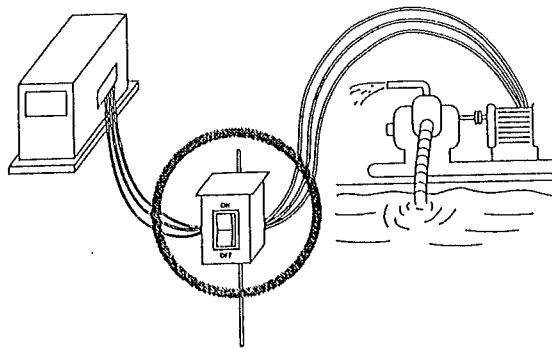

(3) Single-phase Auxiliary Output (100/110V)

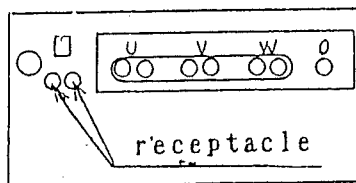

The three-phase output terminal section is provided with two single-phase AUX. receptacles (50/60Hz , 100/110V) used up to 1.5kVA each.

4-4. Cable Selection

Select a properly-thick cable taking into consideration its allowable current and the distance between the generator and the load. The load current flowing through a cable in excess of its allowable current may cause overheating with resultant burning, and the use of a cable that is too thin for its length may result in decreased input voltage to the electrical instruments, causing them to operate with low power or be inoperative.

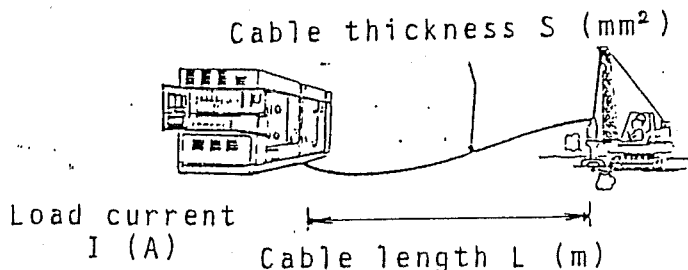

The voltage drop across a cable can be determined from its load current, length and thickness according to the following simplified equation for three-phase three-line system:

$$e = 1/58 \times L/S \times I \times \sqrt{3}$$

where e; Voltage drop (V), L; Cable length (m)

S; Cable thickness (mm) and I; Load current (A).

Select the cable length and thickness so that the voltage drop can be held to within 5%.

5. OPERATION

5-1. Automatic Idling Device

This device automatizes the idling of the engine for its warming-up after startup.

5-2. Operation For and After Startup

(1) Automatic Operation

- ① Set the throttle handle at the desired high-speed position.
- ② Turn the "SPEED" changeover switch on the control panel to "AUTO. IDLING" position.
- ③ Turn the battery switch "ON". At this time, check the "RUNNING CAUTION" lamp is off. If the lamp goes on, turn the "BATTERY" switch to the "OFF" position and then to the "ON" position again before checking that the lamp is "OFF".
- ④ Turn the "STARTER" switch to "PREHEAT" position, and when the PREHEAT lamp goes red-heated, turn the "STARTER" switch to "START" position slowly to start up the engine. When the engine starts to run, release the starter switch.

After engine startup, make sure that the Warning lamp unit "Oil Pressure Failure" lamp is off.

In case of type 220SPM II, change the starter switch to "START" after the going out of the PREHEAT lamp at the position of "RUN".

Note: If the engine is warm, it needs no preheating.

In case of type 220SPM II, the duration of preheating differs according to the temperature of cooling water.

When the temperature of cooling water is high enough, the PREHEAT lamp for preheating does not light because no preheating is needed.

Check that, upon startup, the engine automatically begins idling at a low speed and the "RUNNING CAUTION" lamp goes on. Check that, in 20 seconds, the low-speed idling automatically changes over to operation at the high speed preset with the throttle handle.

- ⑤ If the idling speed is found not to be as specified, correct it according to the following table.

	Idling Speed (Frequency)
50Hz Operation	1575min ⁻¹ (52.5Hz)
60Hz Operation	1875min ⁻¹ (62.5Hz)

- ⑥ Set the voltage to that specified with the voltage regulator and turn the breaker "ON" for power transmission.

- ⑦ Adjust the throttle handle and voltage regulator so that the tachometer, frequency meter and AC voltmeter will stand as in upper drawing for 50Hz operation and as in the lower for 60Hz.



Tachometer
1500min⁻¹

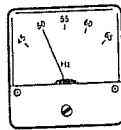

Frequency meter
50Hz

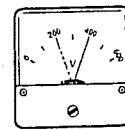

AC voltmeter
200/400V
(380V) (415V)

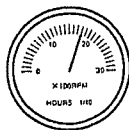

Tachometer
1800min⁻¹

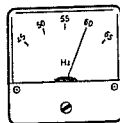

Frequency meter
60Hz

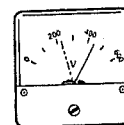

AC voltmeter
220/440V

(2) Continued Low-Speed Operation

Turn the "SPEED" changeover switch on the control panel to "LOW" position.

If the above changeover is made after startup, the idling performed for a given time after startup is followed by the low-speed operation continuing until the changeover switch is turned to "AUTO.IDLING" position.

(3) To change over to high-speed operation soon after startup

(for restart when it is sufficiently warmed up)

Turn the "SPEED" changeover switch on the control panel to the "HIGH" position. This switch setting releases the automatic idling function, allowing the engine to be run at the speed set by the throttle handle.

5-3. Check After Startup

- (1) Check the gauges and lamps for normal operation.
- (2) Check the engine for exhaust color, sound and vibration.
- (3) Check for oil, fuel and water leakage.
- (4) Precautions During Operation

- ① Do not change the switch over to "LOW" during load operation.

In addition, do not start up the engine with the generator and load-side breaker set at "ON" position.

Note that the generator voltage and frequency stand so low during idling operation that the loading instruments may operate but function improperly. During this period, the "RUNNING CAUTION" lamp stays on to warn of this state.

- ② Do not turn off the battery switch or remove the battery during operation.
- ③ If the operation, stopped by operations other than the starter-switch "STOP/OFF" operation (eg. use of "EMERGENCY STOP" button, actuation of the emergency stop device, fuel shortage, engine failure) is to be restarted, first turn the starter switch to "STOP/OFF" position or the battery switch to "OFF" position before performing the ordinary startup operation.

5-4. Shutdown

- (1) Turn the load-side beaker to the "OFF" side.
- (2) Turn the generator beaker to the "OFF" side.
- (3) Turn the "SPEED" changeover switch in the "LOW" position, and continue to run the engine for about several minutes.
- (4) Turn the "STARTER" switch to the "STOP" position.
The engine immediately stops.

Note: No throttle handle adjustment is required to provide the idling speed.

Note: Just after the beginning of the drive of type 220SPMII, the engine may NOT stop soon after the turning of the starter switch to "STOP". It is not abnormal. The engine will stop approximately half minute later. In case of emergency or trouble, keep pushing the emergency stop button until the engine stops.

- (5) Finally, turn the battery switch "OFF".
- (6) For emergency stop, press the "EMERGENCY STOP" button.

5-5. Emergency Stop Device

If any abnormal engine oil pressure failure or water temperature rise occurs during operation, this device shuts down the engine automatically.

6. PARALLEL OPERATION

This section describes the parallel operation of DCA-SPII SERIES. It should be noted here that an efficient parallel operation of engine generators can be attained using the same type.

6-1. Preparation For Parallel Operation

- (1) Make connection between generators and wire them to the load according to the terminal symbols as shown in the following drawing.
* The generators are shipped with the phase sequence set in the order of U, V and W.
Check the phase sequence with a phase meter.

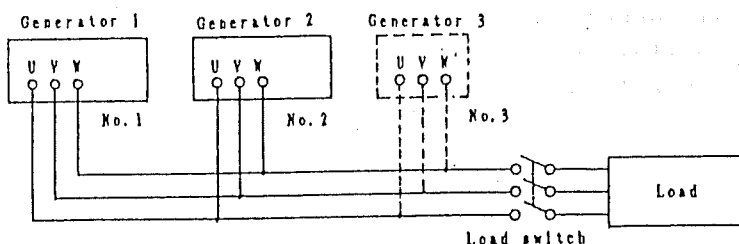

- (2) When generators designed for double voltage (200/220V or 400/440V) are to be used, change all of their output voltages over to the operating voltage.
- (3) Turn the "SINGLE-PARALLEL" changeover switches on the control panels of all the generators to "PAR" position.
- (4) Turn the breakers of all the generators "OFF".

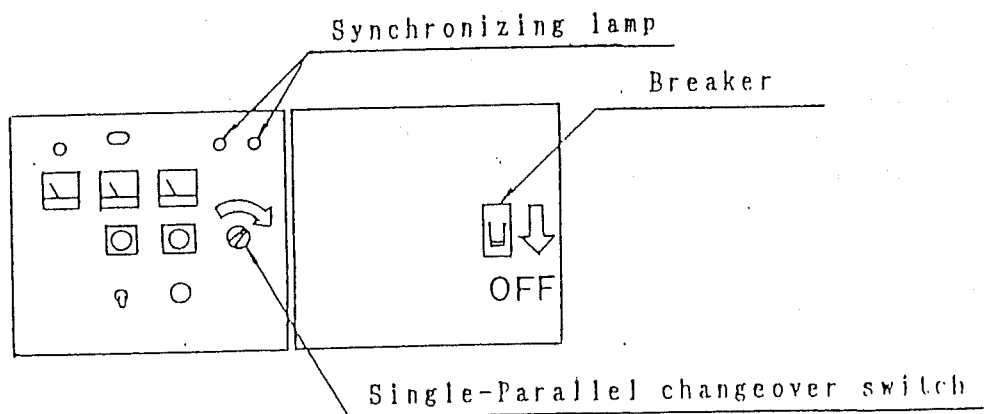

6-2. Operation

- (1) Turn the load switch "OFF".
- (2) Warm up all the generators.
- (3) Set the all-generator frequency (speed) and voltage to the respective same values with the throttle handle and voltage regulator, respectively. This setting requires little subsequent adjustment with the voltage regulator.
- (4) Turn the breaker of No.1 generator "ON".
- (5) Adjust the throttle handle so that the synchronizing lamp of No.2 generator goes on and off at intervals of as long as 5 to 10 seconds. Then, turn the breaker of No.2 generator "ON" the moment the synchronizing lamp of this generator goes off for parallel operation. Repeat the same operation to put No.3 and the following generators, if any, in parallel operation.

Note: The synchronizing lamp of No.2 generator goes on and off simultaneously with that of No.1 generator if both are synchronized with each other in the phase sequence. If not, they alternately go on and off. In such cases, reverse any two of connections U, V and W between the generators.

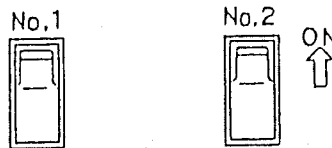

- (6) Note that the generators should have no load applied to them under this condition with no AC current flow. If the voltmeter pointer stands out of "0", mark the zero-point adjustment with the voltage regulator.
- (7) Turn on the load switch. If the generators are found not to be uniform in load current, make adjustments by changing the engine speed with the throttle handle. Turn the throttle handle to "HIGH" side to increase the load share and to "LOW" to decrease it.

6-3. Precautions

- (1) Adjust the throttle handle so that the generators are equal in their load shares during parallel operation.
- (2) Turn the lock of the throttle handle lock clockwise to lock the handle so that it won't loosen and turn during operation.

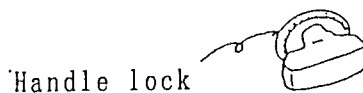

- (3) In operating the generators individually, be sure to turn the "SINGLE-PARA" changeover switches to "SINGLE" side.
- (4) Do not turn the "SPEED" changeover switch to "LOW" position during parallel operation.

7. STORAGE

7-1. Daily Storage

Store the generator horizontally in a place where it will not be exposed to moisture, salt and dust.

7-2. Long-term Storage

Observe the same precautions as taken for daily storage.

For long-term storage of the engine, refer to "Engine Instruction Manual" supplied by the manufacture.

7-3. Two-tier Stacking Of Generators

The generator is designed for two-tier stacking to allow effective place utilization. In stacking the generators in two tiers, observe the following points.

- (1) Stack the generators horizontally on a firm ground.
- (2) Do not stack any machine heavier than this machine.
- (3) Place square bars between the generators as illustrated in the drawing.
- (4) Stack the generators so that the weight of the upper is applied to the lower uniformly.
- (5) In stacking the generators, place one on the other as gently as possible.

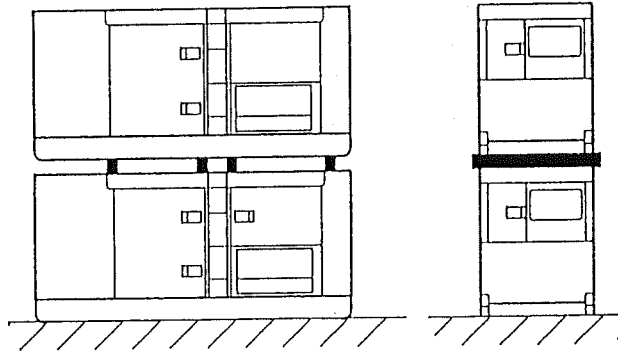

8. MAINTENANCE AND INSPECTION

8-1. Generator

(1) Bearing

Sealed type bearing is provided so that it requires no maintenance. And either bearing-temperature gauge or thermo-label is provided to facilitate inspection for the bearing.

When the bearing-temperature gauge indicates above 80°C, or the color of thermo-label is changed from "white" to "dark brown" by high temperature, it shows that the bearing should be replaced.

(2) Insulation Resistance

Measure the insulation resistance with a 500V-megger at least once every month to check for not less than one megohm.

* Measuring method and allowable limit

As illustrated in the following drawing, remove the load-side wire from the output terminal block, turn the breaker "ON" and measure the insulation resistance between the output terminal bolt and bonnet.

If the insulation resistance thus measured is found to be 0.5 megohm or below, repair the trouble spot to prevent electrocution and fire possibly caused otherwise.

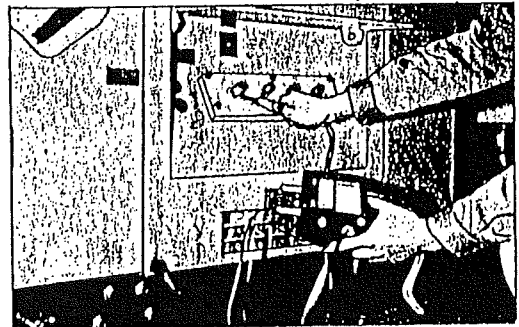

8-2. Control Box

Check the measuring instruments for normal operation.

8-3. Engine

Perform daily and periodic inspections according to the attached "Engine Instruction Manual".

9 . TROUBLESHOOTING

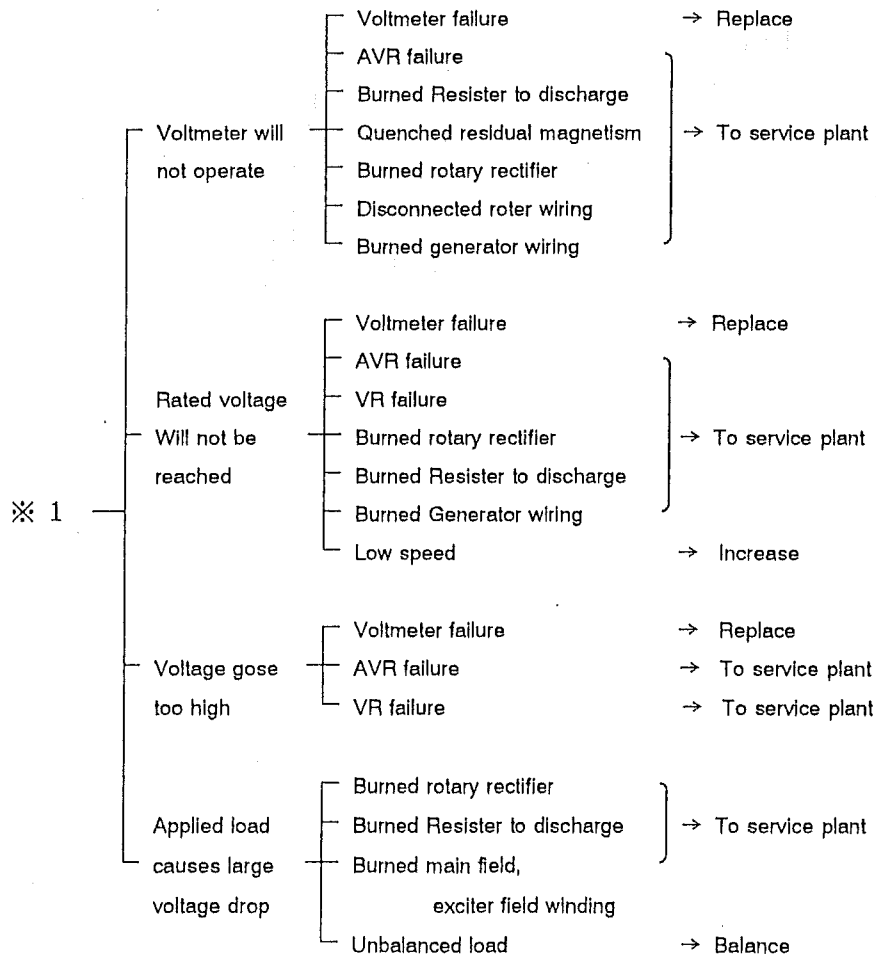
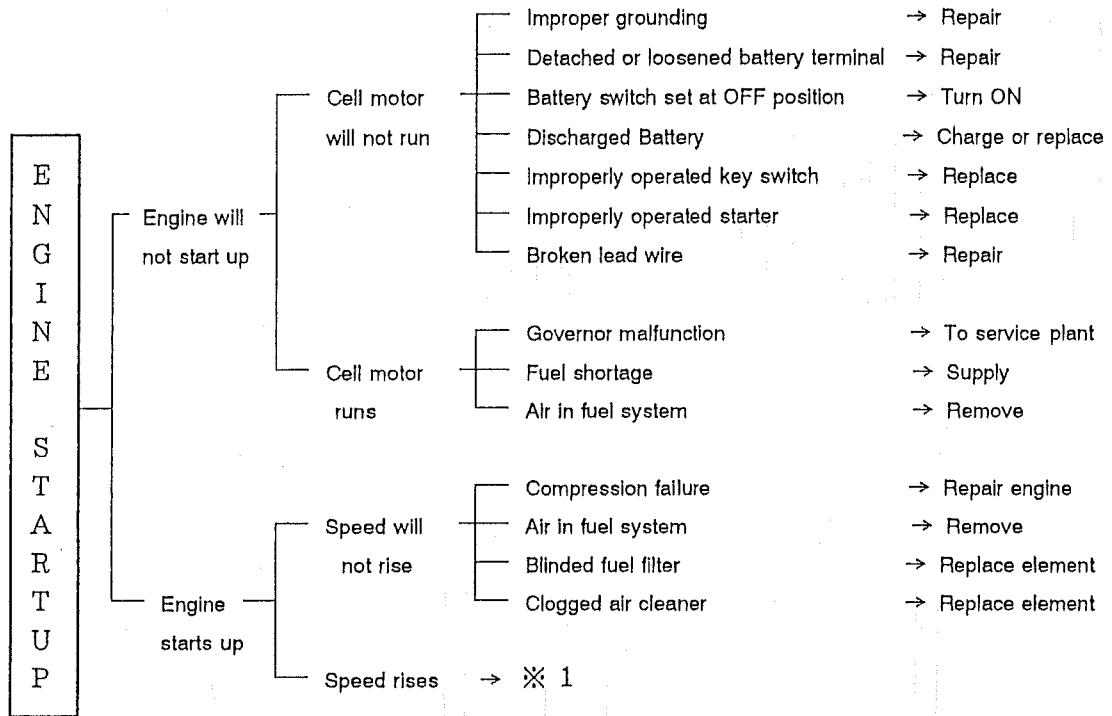

1 0 . GENERATOR CONNECTION DIAGRAM

DCA-220SP

MARK	N A M E
At	MAIN GENERATOR ARMATURE WINDING
Fg	MAIN GENERATOR FIELD WINDING
ExAt	EXCITER ARMATURE WINDING
ExFg	EXCITER FIELD WINDING
AVR	AUTOMATIC VOLTAGE REGULATOR
VR	VOLTAGE REGULATING RHEOSTAT
Re	RECTIFIER
CT1.3	CURRENT TRANSFORMER 400/5A
AS	AMMETER CHANGE-OVER SWITCH
A	AC. AMMETER 0 ~ 400, 800A
VS	VOLTMETER CHANGE-OVER SWITCH
V	AC. VOLTMETER 0 ~ 500V
F	FREQUENCY METER 45 ~ 65Hz
PL1	PILOT LAMP
PL2.3	SYNCHRONIZING LAMP
CB1	CIRCUIT BREAKER 600A
CB2	AUX. CIRCUIT BREAKER 15A
OC	OVER CURRENT RELAY
CON1.2	AUX. POWER RECEPTACLE
IL	PANEL LIGHT
SW1	PANEL LIGHT SWITCH
SW2	SINGLE PAR. CHANGE-OVER SWITCH
SW3	VOLTAGE CHANGE-OVER SWITCH
R1.2	RESISTOR
COT. B	VOLTAGE CHANGE-OVER BOARD
Re1	RECTIFIER

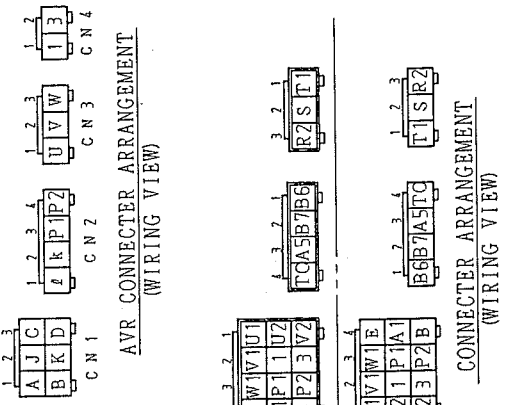
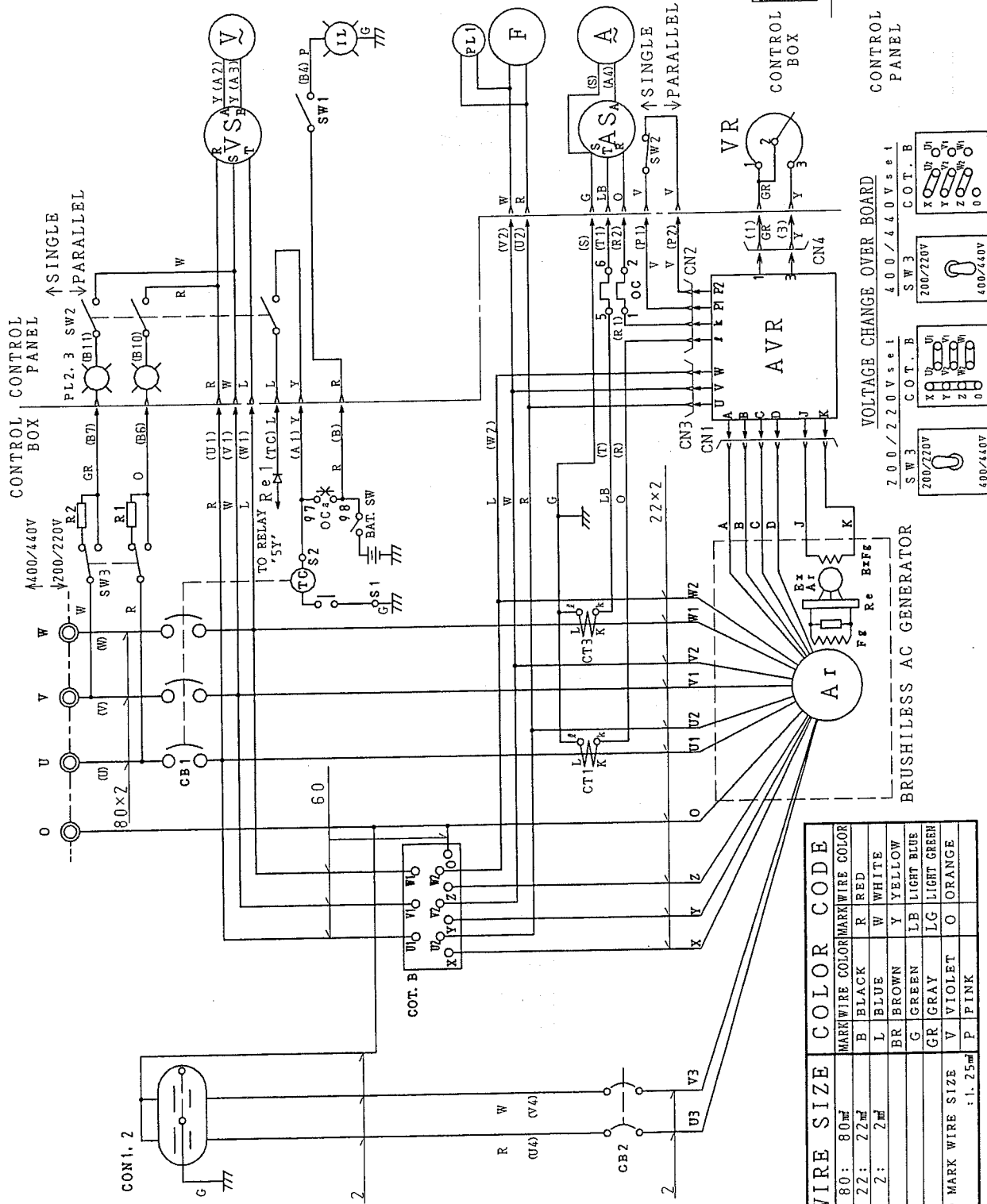

WIRE SIZE	COLOR CODE	MARK WIRE COLOR	MARK WIRE COLOR
80:	80M	B	BLACK
22:	72M	L	BLUE
2:	2M	BR	BROWN
		G	GREEN
		GR	GRAY
		V	VIOLET
		P	PINK

MARK	N	A	M	E
A1				MAIN GENERATOR ARMATURE WINDING
F8				MAIN GENERATOR FIELD WINDING
E1A1				EXCITER ARMATURE WINDING
E1F8				EXCITER FIELD WINDING
AVR				AUTOMATIC VOLTAGE REGULATOR
VR				VOLTAGE REGULATING REHOBSTAT
Re				RECTIFIER
CT1.3				CURRENT TRANSFORMER 500/5A
AS				AMMETER CHANGE-OVER SWITCH
A				AC. AMMETER 0 ~ 500, 1000A
VS				VOLTMETER CHANGE-OVER SWITCH
V				AC. VOLTMETER 0 ~ 600V
F				FREQUENCY METER 45 ~ 65Hz
PL1				PILOT LAMP
PL2.3				SYNCHRONIZING LAMP
CB1				CIRCUIT BREAKER 800A
CB2				AUX. CIRCUIT BREAKER 15A
OC				OVER CURRENT RELAY
CON1.2				AUX. POWER RECEPTACLE
IL				PANEL LIGHT
SW1				PANEL LIGHT SWITCH
SW2				SYNGLE PAR. CHANGE-OVER SWITCH
SW3				VOLTAGE CHANGE-OVER SWITCH
R1.2				RESISTOR
COT. B				VOLTAGE CHANGE-OVER BOARD
Re1				RECTIFIER

DCA-300SP

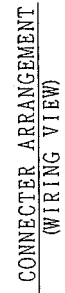
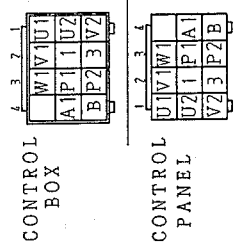
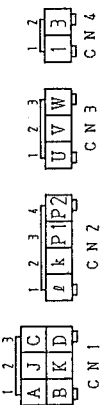
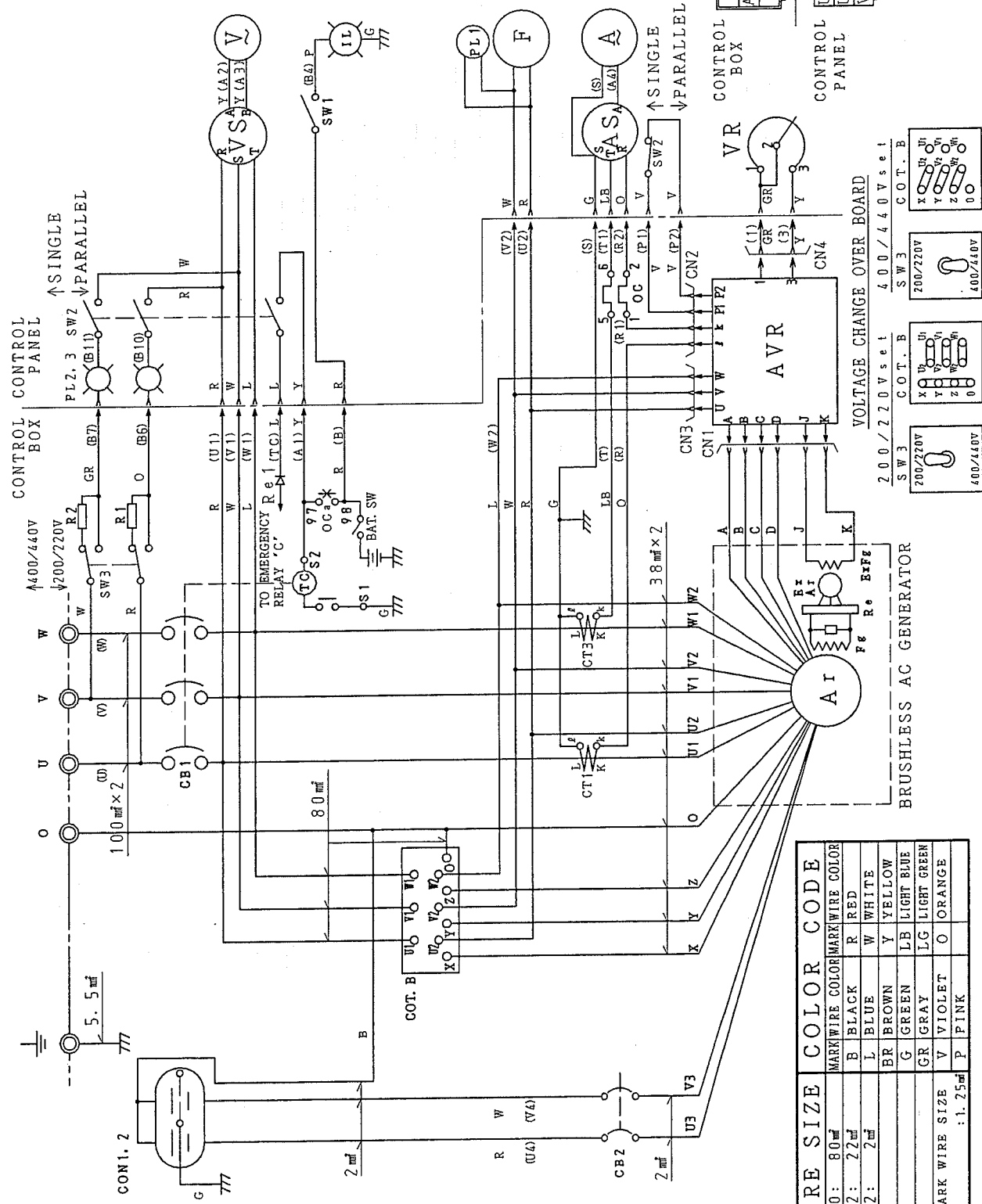

WIRE SIZE	COLOR CODE	MARK	WIRE COLOR
80:	80	B	BLACK
72:	72	L	BLUE
2:	2	BR	BROWN
		G	GREEN
		GR	GRAY
		V	VIOLET
		P	PINK

NO MARK WIRE SIZE: 1.25mm

1 1. ENGINE CONNECTION DIAGRAM

DCA-220SPM II

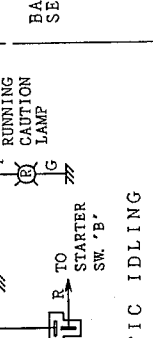
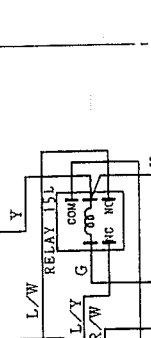
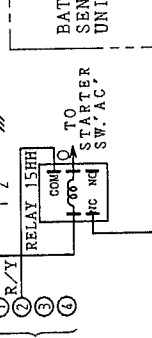
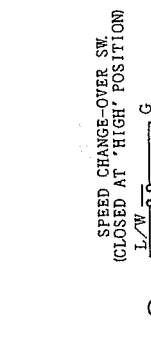
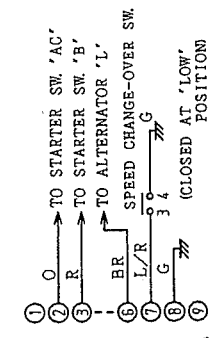
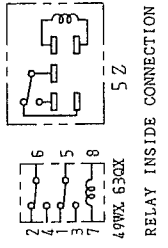
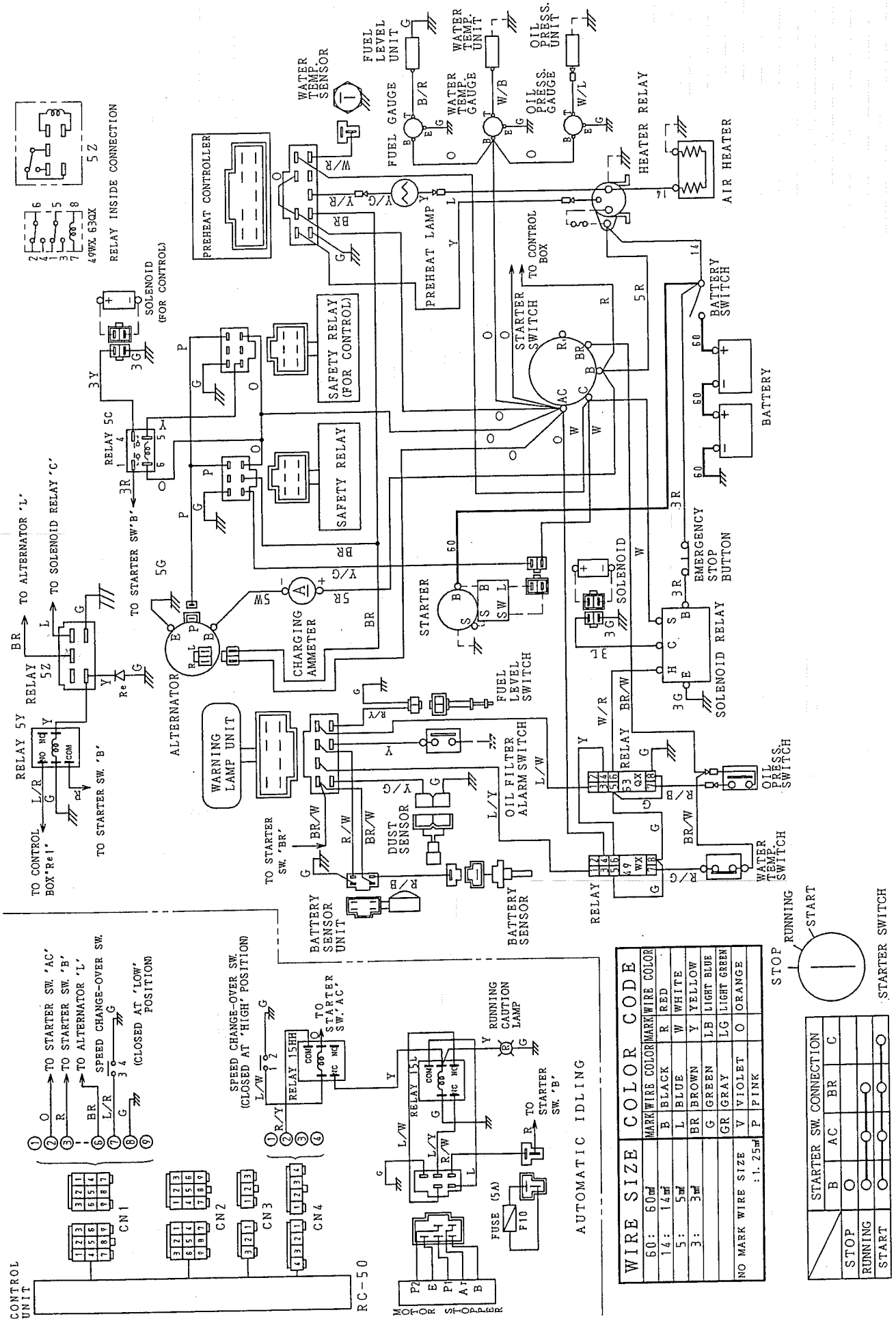

WIRE SIZE	COLOR	MARK	WIRE COLOR	MARK	WIRE COLOR
60	60m	B	BLACK	R	RED
14	14m	L	BLUE	W	WHITE
5	5m	BR	BROWN	Y	YELLOW
3	3m	G	GREEN	LB	LIGHT BLUE
		GR	GRAY	LG	LIGHT GREEN
		V	VIOLET	O	ORANGE
		P	PINK		

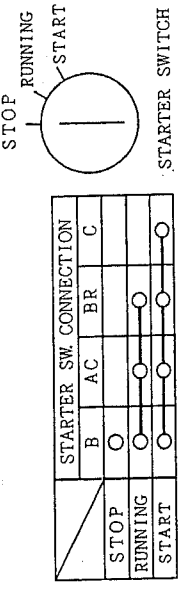

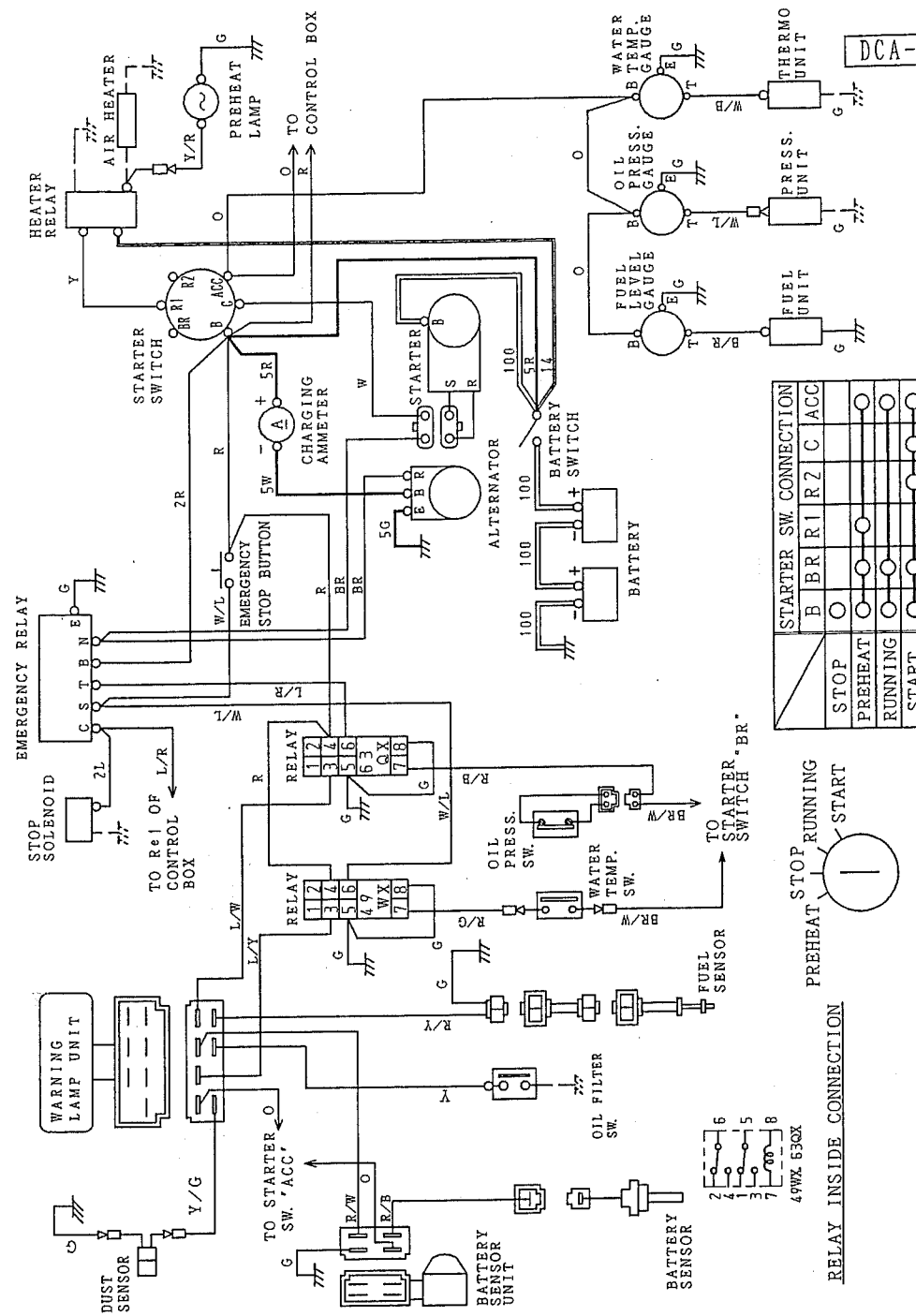

STARTER SW CONNECTION

	B	BR	R1	R2	C	ACC
STOP	○	○	○	○	○	○
PREHEAT	○	○	○	○	○	○
RUNNING	○	○	○	○	○	○
START	○	○	○	○	○	○

RELAY INSIDE CONNECTION

100:	100mm ²	WIRE COLOR	WIRE COLOR
38:	38mm ²	B	BLACK
22:	22mm ²	L	BLUE
14:	14mm ²	BR	BROWN
5:	5mm ²	G	GREEN
2:	2mm ²	GR	GRAY
OTHERS: 1. 25mm ²		V	VIOLET
		P	PINK

COLOR CODE

WIRE COLOR	WIRE COLOR
B	BLACK
L	BLUE
BR	BROWN
G	GREEN
GR	GRAY
V	VIOLET
P	PINK

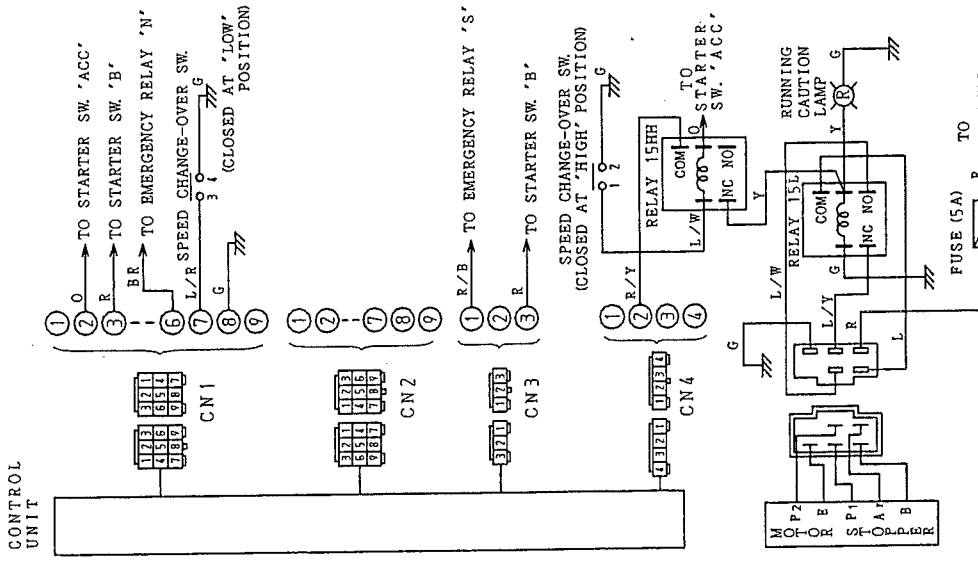

AUTOMATIC IDLING

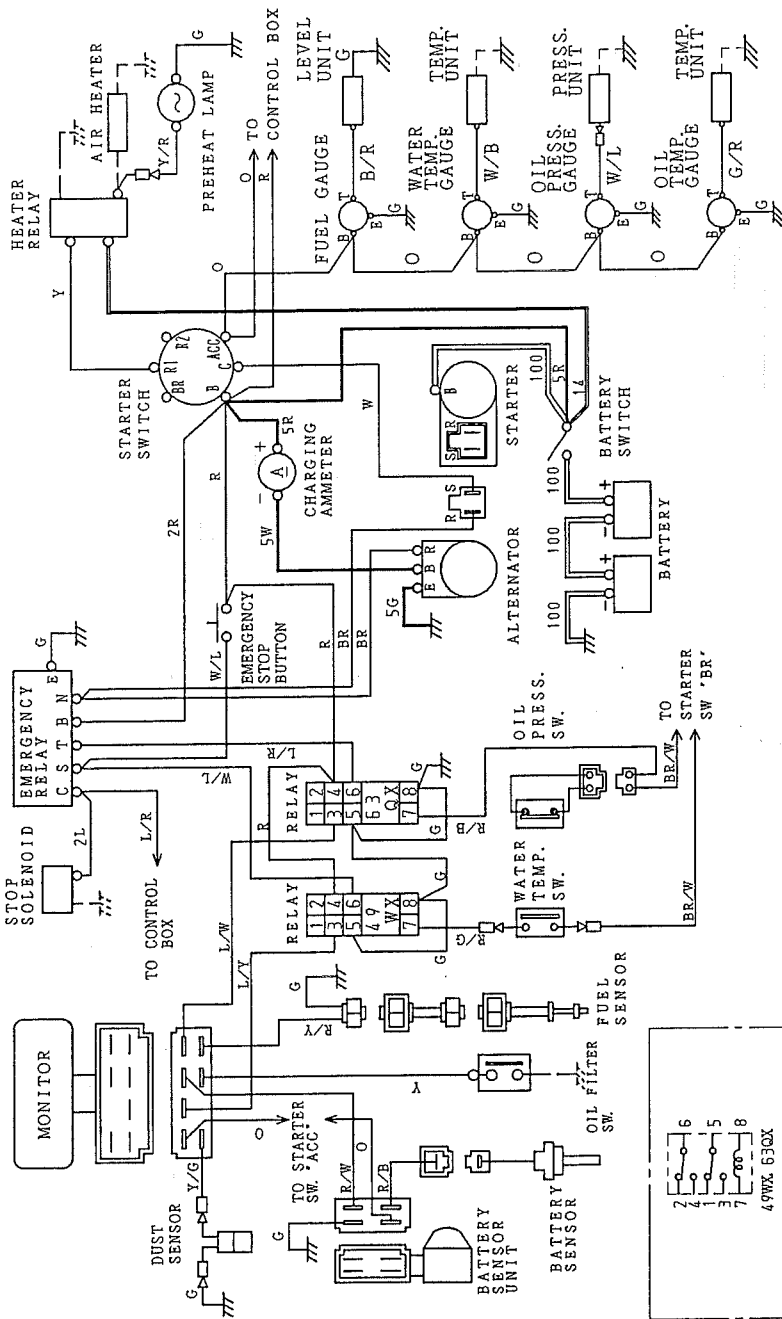

STARTER SW CONNECTION		B	BR	R1	R2	C	ACC
STOP		○	○	○	○	○	○
PREHEAT		○	○	○	○	○	○
RUNNING		○	○	○	○	○	○
START		○	○	○	○	○	○

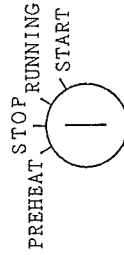

NOTE
CONNECTER ARRANGEMENT: WIRING VIEW

RELAY INSIDE CONNECTION		WIRE SIZE	COLOR CODE
100:	100mm ²	WIRE COLOR	WIRE COLOR
38:	38mm ²	B BLACK	R RED
22:	22mm ²	L BLUE	W WHITE
14:	14mm ²	BR BROWN	Y YELLOW
5:	5mm ²	G GREEN	LB LIGHT BLUE
2:	2mm ²	GR GRAY	LG LIGHT GREEN
NO MARK WIRE SIZE		V VIOLET	O ORANGE
		: 1.25mm	

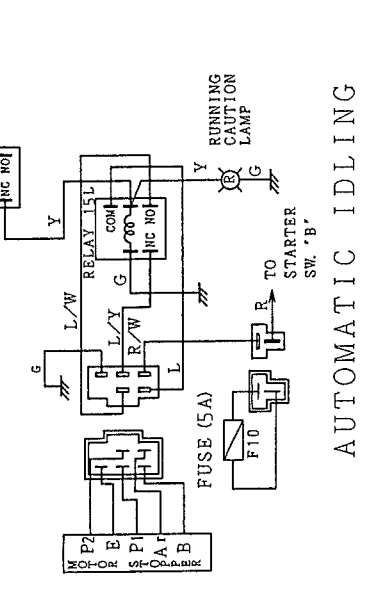
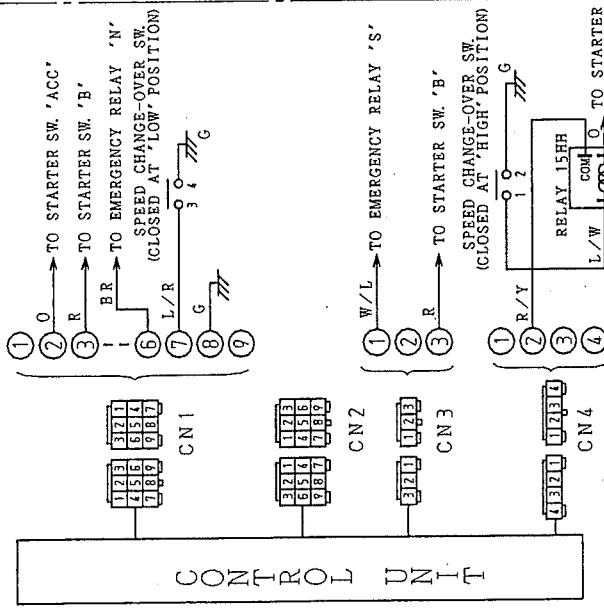

AUTOMATIC IDLING

1 2 . SAFETY PRECAUTIONS FOR DIESEL GENERATING SETS AND EQUIPMENT

To be read attentively before installing, operating
or repairing the unit

- * In addition to general safety rules which should be observed with diesel generating sets and equipment, the following safety directions and precautions are of special importance.
- * When operating this unit, the operator is expected to employ safe working practices and to observe all related local work safety requirements and ordinances.
- * The owner is responsible for maintaining the unit in a safe operating condition. Parts and accessories shall be replaced if unsuitable for safe operation.
- * Installation, operation, maintenance and repair shall only be performed by authorized, trained, competent personnel.
- * If any statement in this book, especially with regard to safety, does not comply with local legislation, the stricter of the two shall apply.
- * These precautions are general and cover several machine types and equipment: hence some statements may not apply to the unit(s) described in this book.

12-1. Installation

Apart from general engineering practices that conform with the local safety regulations, the following directives are especially stressed:

- ① Engine exhaust contains noxious elements.
Therefore, pay close attention to ventilation when operating the generator set inside tunnels, buildings, or other enclosed areas.
- ② For outdoor operation, install the generator set so that the exhaust is not discharged in the direction of nearby homes or other enclosed areas.
- ③ When the generator sets is installed in a dusty or corrosive atmosphere, frequently inspect it for radiator clogging and other abnormal conditions.
- ④ Provide adequate space for engine inspection, lubrication, refueling, cable connection to the load, and operation.
- ⑤ Never remove or tamper with the safety devices, guards or insulations fitted on the unit.
- ⑥ Be sure that the generating set is on secure and level ground.

12-2. Operation

- ① Select cables of proper thickness while referring to the load capacity and distance to the load. Then, securely connect them. Do not use any cable whose cover is broken and degraded. In connecting the cable, be sure to shut down the operation. Cover or tape the connections to prevent leakage and direct contact with the human body.
- ② Always set voltmeter and frequency meter at the rated. Set ammeter below rated current.
- ③ All canopy doors should be shut during operation.
- ④ People staying in environments or rooms where the sound pressure level reaches or exceeds 90 dB(A) shall wear ear protectors.
- ⑤ The following items should be checked before startup:
 - a) All guards should be in place and securely fastened.
 - b) Water, engine oil or fuel leakage
 - c) That all fasteners are tight
 - d) That all electrical leads are secure and in good order
 - e) Oil level and cleanliness
 - f) Cooling water level (radiator and overflow tank) and radiator cap securely tightened
 - g) Fuel level
 - h) Tension of all V-belts
- ⑥ Provide a switch between the generator and load to operate or stop the load.
- ⑦ Always keep battery switch turned ON while operating the engine. Also, always keep it OFF when engine is not running.
- ⑧ Do not wire the generator set the interior circuit.
- ⑨ Avoid low-load operation for long periods of time.

- ⑩ Coolant: Use clean water.
When the temperature drops to (32 F) or below, the following measures must be taken:
 - a) Use antifreeze
 - b) When antifreeze is not used,
Open drain cocks of the engine and radiator to completely drain off cooling water after engine operation.
- ⑪ Fill the fuel tank frequently.
Periodically open the drain plug to drain moisture and contaminants.
- ⑫ Avoid high speed operation immediately after starting.
- ⑬ Never turn the starter switch to "START" position while the engine is running.
- ⑭ Never stop the engine suddenly except in an emergency.
- ⑮ Never touch any rotating, hot, and live parts during operation.

12-3. Maintenance

Maintenance and repair work shall only be carried out under supervision of someone qualified for the job.

- ① Use only the correct tools for maintenance and repair work.
- ② Use only genuine spare parts.
- ③ All maintenance work, other than routine attention, shall only be undertaken when the unit is stopped.
- ④ Never use flammable solvents or carbon tetrachloride for cleaning parts. Take safety precautions against toxic vapours of cleaning liquids.
- ⑤ Scrupulously observe cleanliness during maintenance and repair. Keep dirt away by covering the parts and exposed openings with a clean cloth, paper or tape.
- ⑥ Make sure that no tools, loose parts or rags are left in or on the unit.
- ⑦ Protect the electrical and regulating components, etc. to prevent moisture from entering these parts, e.g. when steam-cleaning.
- ⑧ Do not remove or tamper with the sound damping material in order to maintain the proper sound pressure level.

All responsibility for any damage or injury resulting from neglecting these precautions or by non-observance of ordinary caution and due care required in handling, operating, maintenance or repair, even if not expressly mentioned in this book, will be disclaimed by Denyo Co., LTD.

